

Instructions for Hang Space™ Tri

WHAT'S IN THE BOX

Your Hang Space™ Tri Includes: (1) Hang Space, (1) Carry Bag and Stake Set (3)

HANG SPACE™ TRI SET UP

NOTE: This accessory is intended to be installed in the corner of your shelter.

1. Completely set up your shelter product in the area that you intend to shade according to the owner's manual instructions, leaving at its lowest height setting.
2. Select desired corner of shelter to begin install of Hang Space and fold up the **Fabric Top Corner** as illustrated. (Fig A)

NOTE: Step 3 will be different dependent on shelter.

3. Locate the two **Corner Truss Clips** on the Hang Space next to the hook and loop. From interior of shelter, attach Truss Clips.

Cross Truss Shelter - Attach Truss Clips to the **Top Corner Trusses** on adjacent sides of **End Cap**. (Fig B)

Open Truss Shelter - Attach Truss Clips to the **Corner Lower Trusses** on adjacent sides of **End Cap**. (Fig C)

4. Locate the **Left Truss Clip** on the Hang Space and attach to your shelter, remembering to attach to the left of the **Nut & Bolt Assembly**.

Cross Truss Shelters - Attach Truss Clip to the left Top Truss. (Fig. D)

Open Truss Shelter - Attach Truss Clip to the left Lower Truss. (Fig. E)

5. Locate the **Right Truss Clip** on the Hang Space and attach to your shelter remembering to attach to the left of the **Nut & Bolt Assembly**.

Cross Truss Shelters - Attach Truss Clip to the right Top Truss. (Fig. F)

Open Truss Shelter - Attach Truss Clip to the right Lower Truss. (Fig. G)

6. Raise your shelter to preferred height setting.

7. Tighten or loosen **Adjustment Straps** to achieve best fitment. (Fig. H)

NOTE: It is recommended that you use genuine **Weight Bags, Spike or Stake Kits** to secure your Hang Space. To fully enclose your Hang Space, utilize zippers located on opposite corners of the Hang Space.

TAKE DOWN

1. Repeat steps in reverse of assembly.

CARE & MAINTENANCE

- Use a mild soap (not detergent) and plenty of water for cleaning. Let dry completely before closing or storing to avoid mildew.
- Store in the Carry Bag Provided.

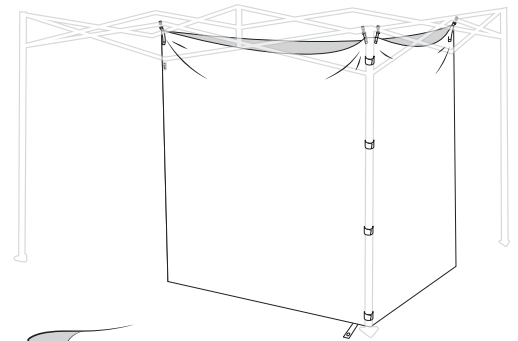

Fig. A

Fabric Top Corner

Fig. B

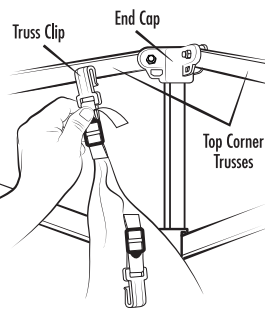

Fig. D

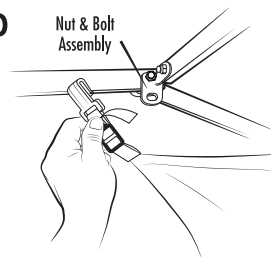

Fig. F

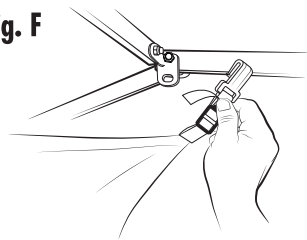

Fig. C

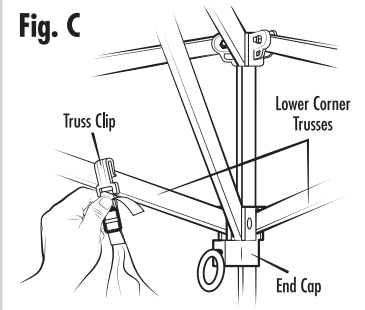

Fig. E

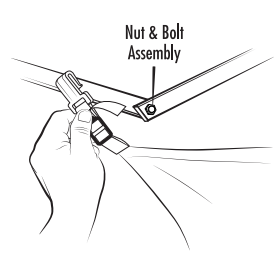

Fig. G

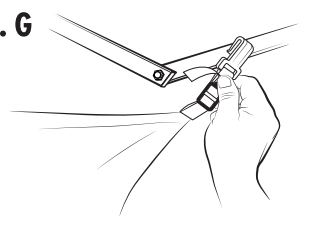
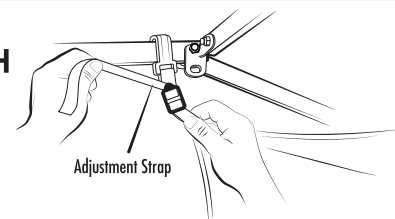

Fig. H



Instructions for Hang Space™ Square

WHAT'S IN THE BOX

Your Hang Space™ Square Includes: (1) Hang Space, (1) Carry Bag, and Stake Set (4)

HANG SPACE™ SQUARE SET UP

NOTE: This accessory is intended to be installed in the corner of your shelter.

Hang Space Square is only functional on a Cross Truss Shelter.

1. Completely set up your shelter product in the area that you intend to shade according to the owner's manual instructions, leaving at its lowest height setting.
2. Select desired corner of shelter to begin install of Hang Space and fold up the **Fabric Top Corner** as illustrated. (Fig A)
3. Locate the two **Corner Truss Clips** on the Hang Space next to the hook and loop. From interior of shelter, attach Truss Clips to the **Top Corner Trusses** on adjacent sides of **End Cap**. (Fig B)
4. Locate the **Left Corner Truss Clip** on the Hang Space and attach Truss Clip to the left Top Truss, remembering to attach to the left of the **Nut & Bolt Assembly**. (Fig. C)
5. Locate the **Right Corner Truss Clip** on the Hang Space and attach Truss Clip to the right Top Truss, remembering to attach to the right of the Nut & Bolt Assembly. (Fig. D)
6. Locate the last Truss Clip on the Hang Space. Attach Truss Clip to the Top Truss next to the **Peak Slider**. (Fig. E)
7. Raise your shelter to preferred height setting.
8. Tighten or loosen **Adjustment Straps** to achieve best fitment. (Fig. F)

NOTE: It is recommended that you use genuine Weight Bags, Spike or Stake Kits to secure your Hang Space. To fully enclose your Hang Space, utilize zippers located on opposite corners of the Hang Space.

TAKE DOWN

1. Repeat steps in reverse of assembly.

CARE & MAINTENANCE

- Use a mild soap (not detergent) and plenty of water for cleaning. Let the Gear dry completely before closing or storing to avoid mildew.
- Store in the Carry Bag Provided.

