

Vector Frame R-08

VF-R-08

Vector Frame™ is a collection of modern extrusion-based fabric graphic banner displays. Vector Frame is easy to assemble and disassemble and provides your choice of single-sided or double-sided integrated fabric graphic murals.



features and benefits:

- 50mm silver extrusion frame
- Single or double-sided SEG dye-sublimated fabric graphics
- Easy assembly
- Comes packaged in two OCE wheeled molded case for transport or storage
- Lifetime hardware warranty against manufacturer defects

dimensions:

Hardware	Graphic
<p>Assembled unit: 354.58" w x 94.74" h x 19.7" d 9006mm(w) x 2406mm(h) x 500mm(d)</p> <p>Approximate weight: 143 lbs / 65 kgs</p>	<p>Refer to related graphic template for more information.</p>
<p>Shipping</p> <p>Packing case(s): 2 OCE Case</p> <p>Shipping dimensions: OCE: Expandable case length (l) may vary 40" - 66" l x 18" w x 18" h 1016mm-1677mm(l) x 458mm(w) x 458mm(h)</p> <p>Approximate total shipping weight (includes cases & graphics): 193 lbs / 88 kgs</p>	<p>additional information:</p> <p>Graphic material: dye-sublimation fabric</p> <p>When included in a larger kit, a different packaging solution will be listed to accommodate all contents of the kit. Individual packaging no longer provided.</p>

We are continually improving and modifying our product range and reserve the right to vary the specifications without prior notice. All dimensions and weights quoted are approximate and we accept no responsibility for variance. E&OE. See Graphic Templates for graphic bleed specifications.

Included In Your Kit

Tools, Components, Extrusions & Connectors



5MM ALLEN-T x1

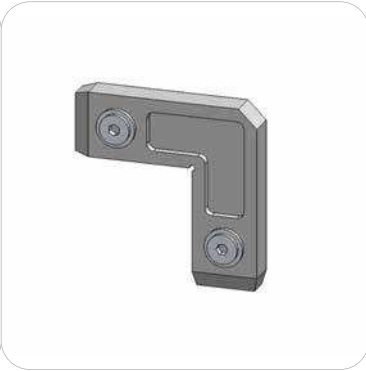

CB9 x4

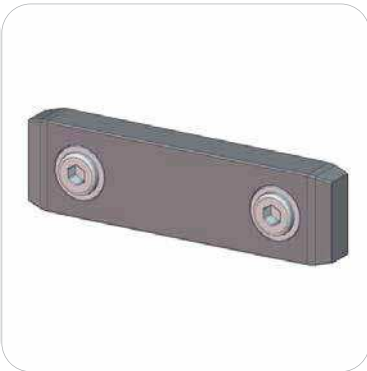

IB2 x23



SW-FOOT-500-LN x2

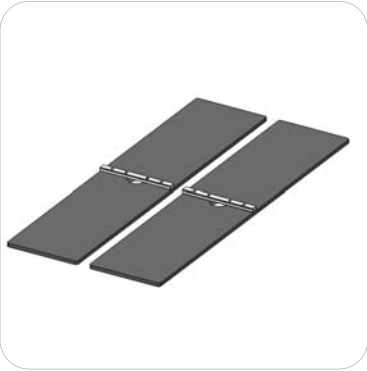

LN114-S2-450-TT x3



PH1-1155-L1-S x14

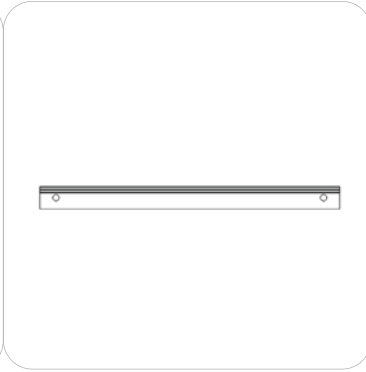

PHFC2-900-L1-L1 x4

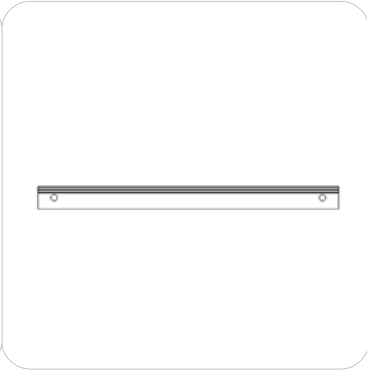

PHFC2-1200-L1-L1 x8



PHFC2-1200-L1-MCB9 x8

Graphics



VF-R-08-S-G x1



VF-R-08-OP-LN x1

Exploded View

VF-R-08

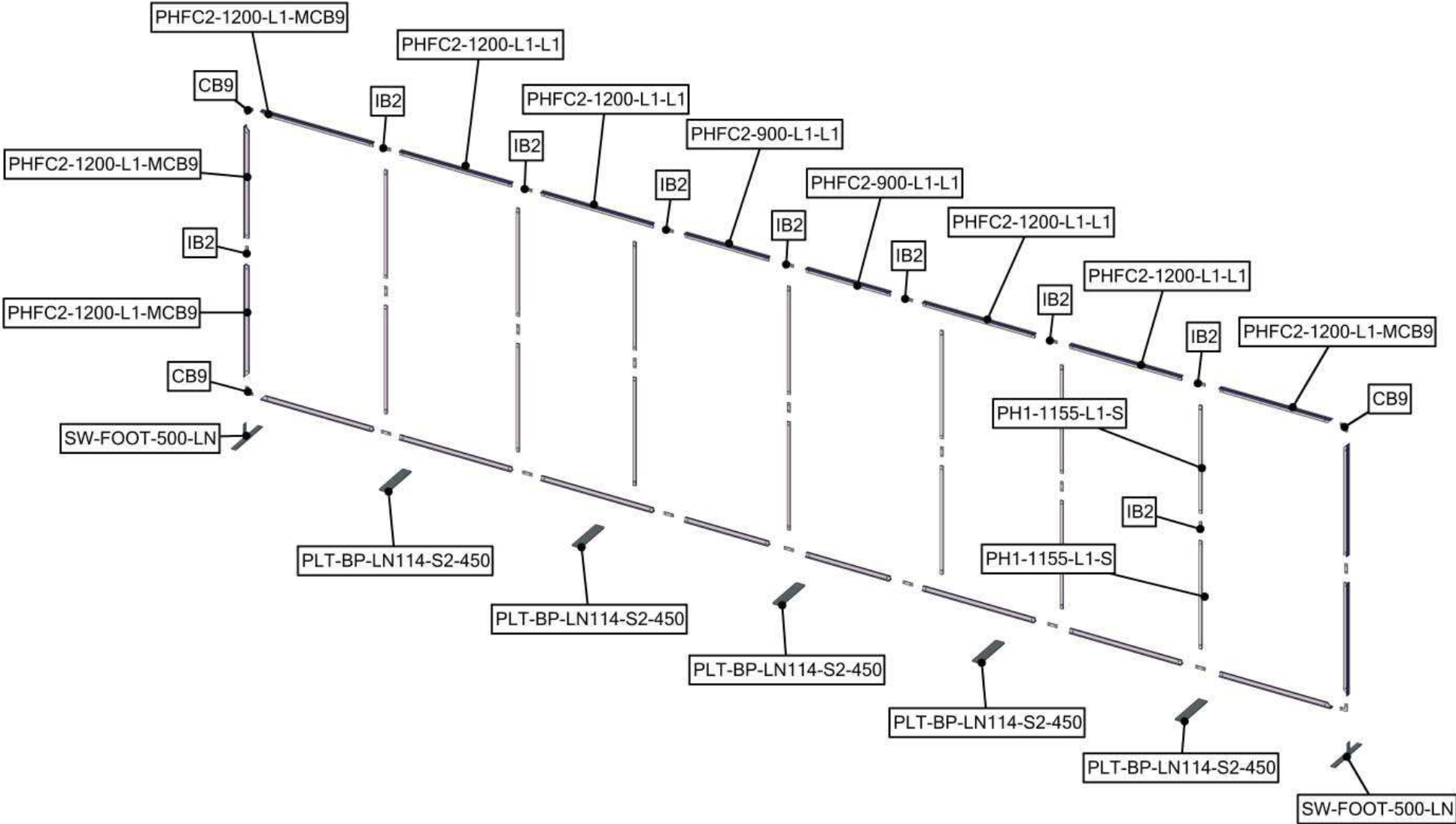

Connection Methods

Extrusion based structures use a number of different yet simple connection methods. Your kit will include one or more of the connection methods shown below. Steps within the Kit Assembly will reference a specific method for each connection point.

Connection Method 1: Cam Lock / Slide Lock

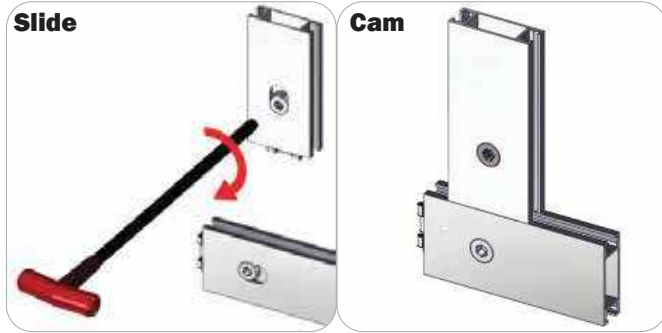

A cam lock equipped extrusion can lock to any cam lock channel. With the cam lock unlocked, set the teeth of the cam lock into the desired position on the cam lock channel. Using your allen key tool, carefully turn the lock clockwise to lock in place. Be sure to lock securely, but do not over tighten.

A slide lock equipped extrusion can also lock into any cam lock channel. When the slide lock is unlocked, pull back on the hex bolt head to retract the slide lock into the body of the extrusion. Slide locking procedure is the same as a cam lock.

Connection Method 2: IB2 / Corner Brackets

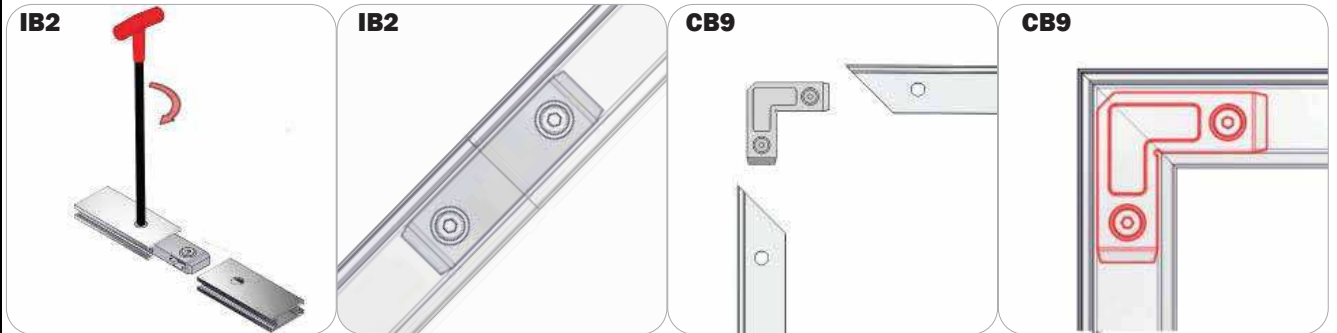

Press the hex bolt head in with your thumb and slide the extrusion and connector together so that the hex bolt head sits into the lock hole. Repeat with the second extrusion to the free end of the connector. Lock the extrusions together by turning carefully with the allen key tool. Be sure to lock securely, but do not over tighten.

Connection Method 3: SW-FOOT

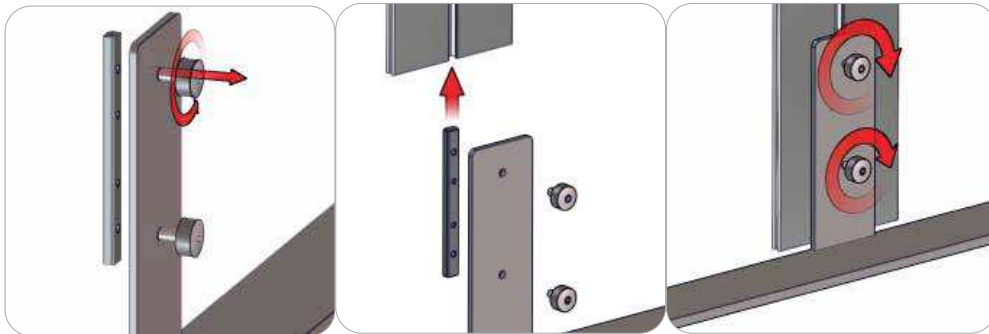

An SW-FOOT assembly consists of two thumb screws, an LN100, and SW-FOOT baseplate. Start by loosening the thumb screws (it is best not to completely remove the screws). Slide the extrusion onto the LN100 by utilizing its back cam channel. When the extrusion rests on baseplate or ground (depending on application), tighten the thumb screws to lock in place. Do not over tighten.

LN114-S2



Kit Assembly

Step by Step

Step 1.

Locate the components necessary for assembling the frame. Assemble your frame in order according to the Exploded Diagram.

Please reference Connection Methods 1 and 2 for more details.

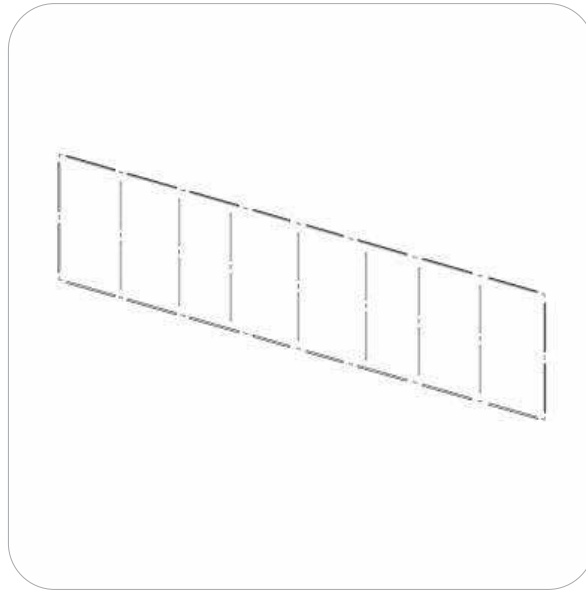
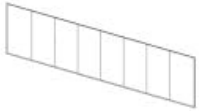

Step 2.

Locate your silicone edge fabric panels. Push the silicone edges of the graphic panel into the front grooves of the PHFC2 extrusion perimeter. Push the silicone edges of the opaque liner into the back grooves of the PHFC2 extrusion perimeter.

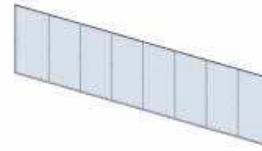

Step 3.

Gather the components necessary for assembling your frame stabilizing bases. Assemble in the order the Exploded View instructs.

Refer to Connection Method 3 for additional information.

Setup Complete.

