

# Formulate Backlit Straight 50mm - 10ft

## FMLT-BL-WS10-01

The Formulate® 10ft Straight Backlit display is a captivating and eye-catching exhibit that combines an aluminum tube frame with an LED light curtain and a zipper pillowcase printed fabric graphic. The LED light curtain helps draw attention to the display and offers even and bright white light balance throughout. An expandable, sturdy display case is included to protect the frame and LED light curtain in transit to events and tradeshows.



## features and benefits:

- State-of-the-art 50mm aluminum tube frame with spigot assembly
- LED light curtain easily attaches to the frame at the top and bottom
- Pillowcase fabric graphic is printed on backlit textile and includes an opaque backer
- Kit includes: one frame, one dye-sublimated zipper pillowcase graphic, and one wheeled OCE molded storage case
- Quick to set up
- Easy to store and ship
- Lifetime hardware warranty against manufacturer defects

## dimensions:

### Hardware

### Graphic

Assembled unit:  
115.94"w x 92"h x 25.59"d  
2945mm(w) x 2337mm(h) x 650mm(d)

Refer to related graphic template for more information.

Approximate weight:  
67 lbs / 31 kg

One year warranty.

### Shipping

## additional information:

Packing case(s):  
1 OCE

Graphic material:  
Dye-sublimation zipper pillowcase fabric

Shipping dimensions:  
OCE: Expandable case length (l) may vary  
40" - 66"l x 18"h x 18"d  
1016-1677mm(l) x 458mm(h) x 458mm(d)

When included in a larger kit, a different packaging solution will be listed to accommodate all contents of the kit. Individual packaging no longer provided.

Approximate total shipping weight:  
92 lbs / 42 kg

# Included In Your Kit

Tools, Components, & Connectors



FMLT-BL-WS10-01-T3 x2



FMLT-BL-WS10-01-T4 x2



FMLT-BL-WS10-01-T2 x2



FMLT-BL-WS10-01-T1 x4



PLT-BP-LN114-S2-650 x2



ES50-2W x2



ES50-I-ES50-C-ASY x2



LED PANEL 600mm x4



ES50 x6



FMLT-BL-CURTAIN-TRANS-2 x1



FMLT-BL-CURTAIN-TRANS-1 x1

# Included In Your Kit

Graphics

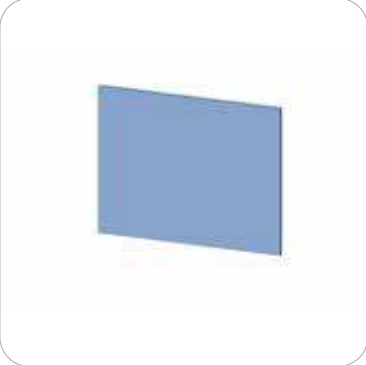

FMLT-BL-WS10-01 x1

# Exploded Diagram

FMLT-BL-WS10-01

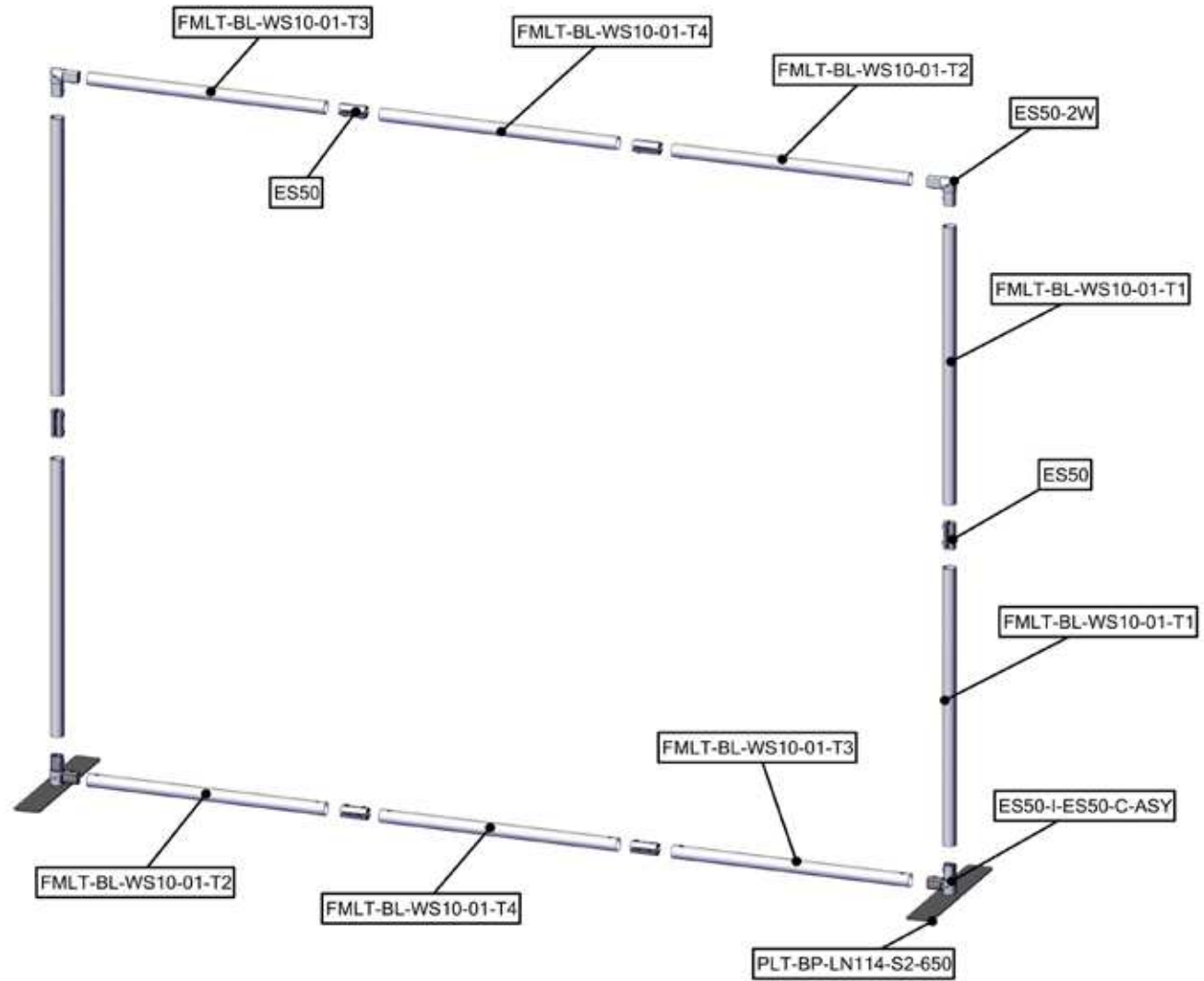

# Labeling Diagram

FMLT-BL-WS10-01

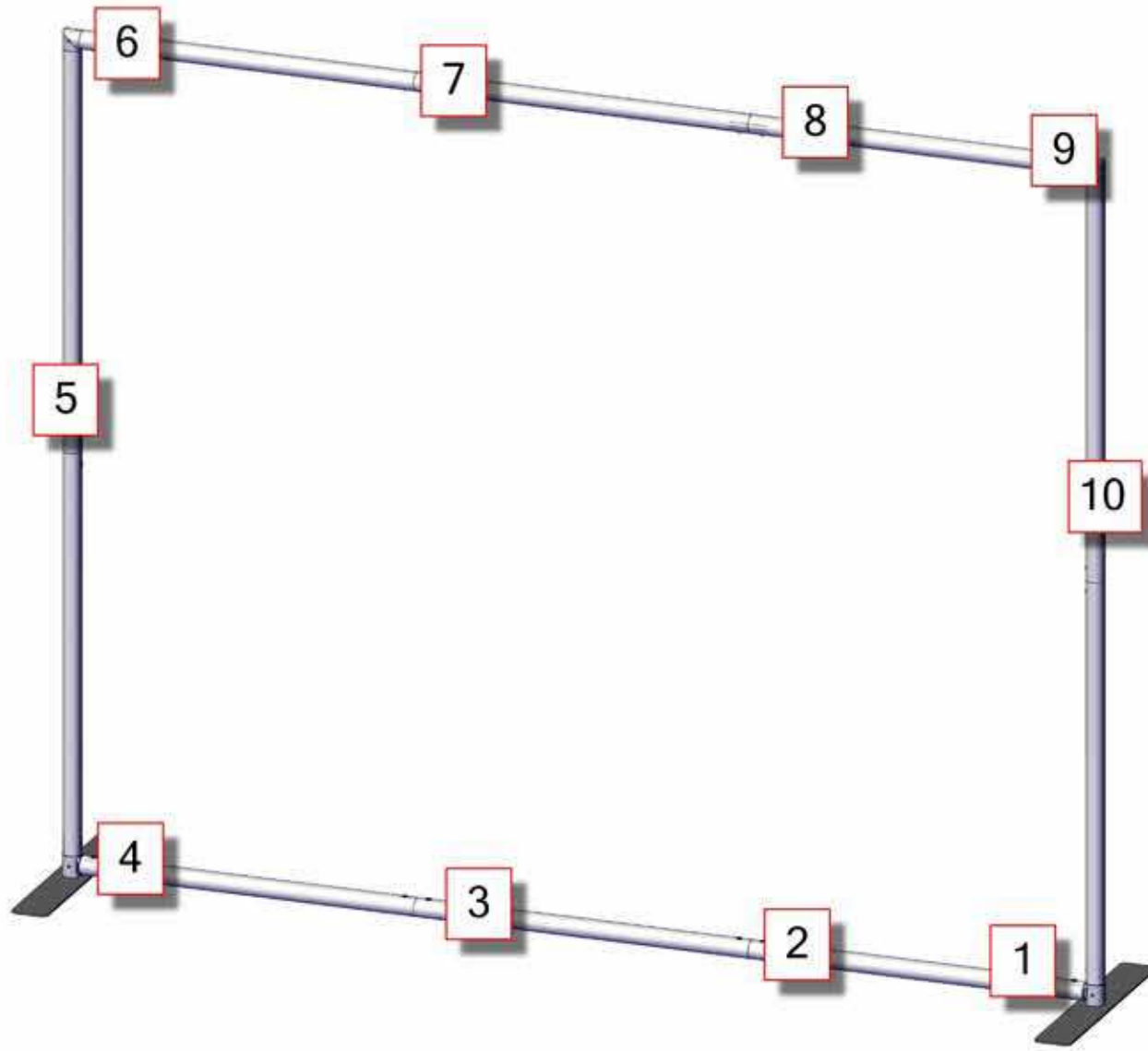

# Kit Assembly

## Step by Step

### Step 1.

Gather the components to build the frame. Use the Exploded View and the Labeling Diagram for part labels.

Reference Connection Method(s) 1, 2 for more details.

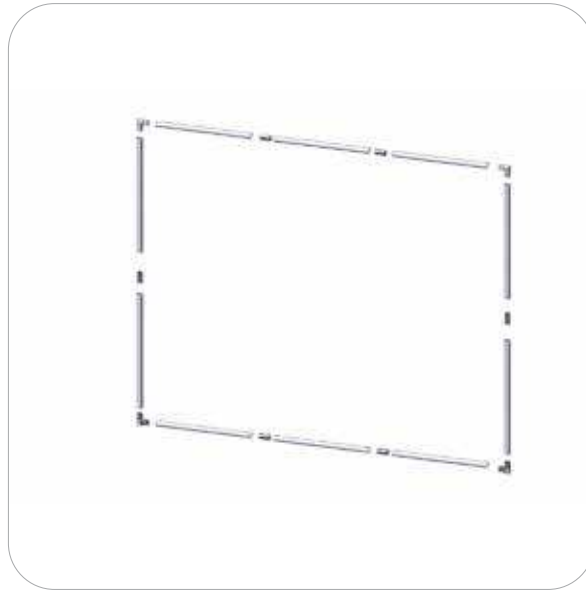
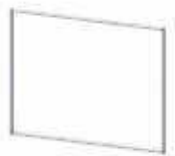

### Step 2.

Gather the components to attach the bases. Use the Exploded View and the Labeling Diagram for part labels.

Reference Connection Method(s) 3 for more details.



### Step 3.

Gather the components to assemble lighting. Use the Exploded View and the Labeling Diagram for part labels.



### Step 4.

Connect both FMLT-BL-CURTAIN-TRANS-1 & FMLT-BL-CURTAIN-TRANS-2 to the curtain lights. Large trans can only hold 3 set of curtains lights. So, this is why the extra small trans is needed.

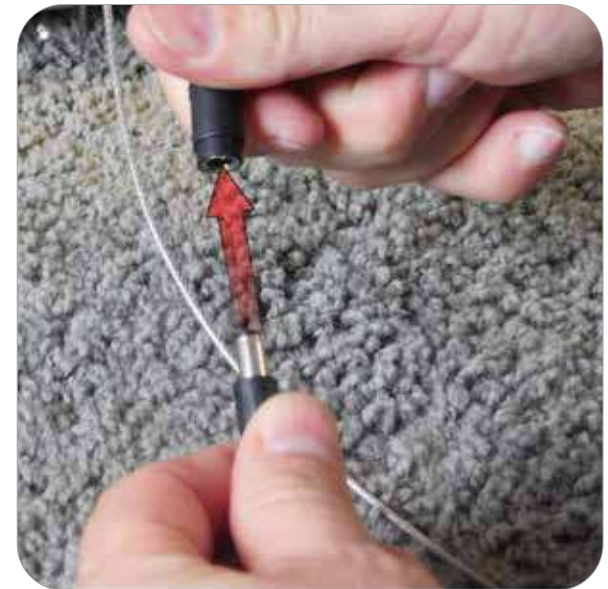

# Kit Assembly

## Step by Step

### Step 5.

Slide graphic over top of frame.  
Once in place the graphic may be zipped at the bottom.

Setup is complete.

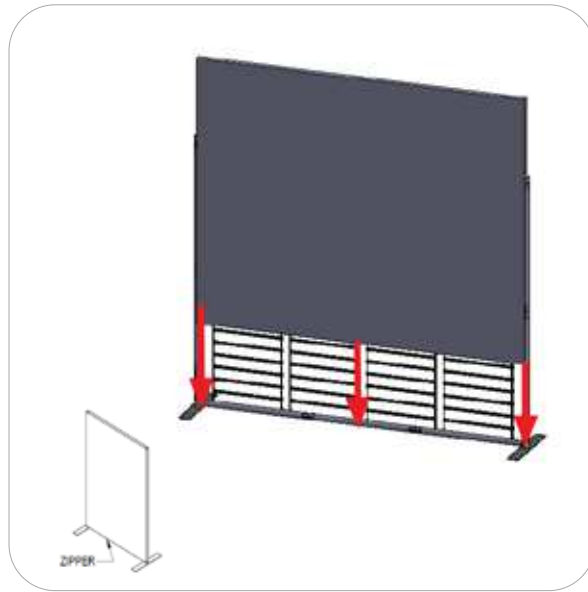

# Connection Methods

## Connection Method 1: ES50-2W



For spigot connections, compress the unlocked connector and slide into the tube lock access hole. Lock both screws carefully using your allen key tool. Be sure to lock securely, but do not over tighten. Do not force the connection and be careful with the tube edges, they may be sharp. To disassemble, unlocked connector press the snap button and pull apart.

## Connection Method 2: ES300-D-ES50-S-ASY-2

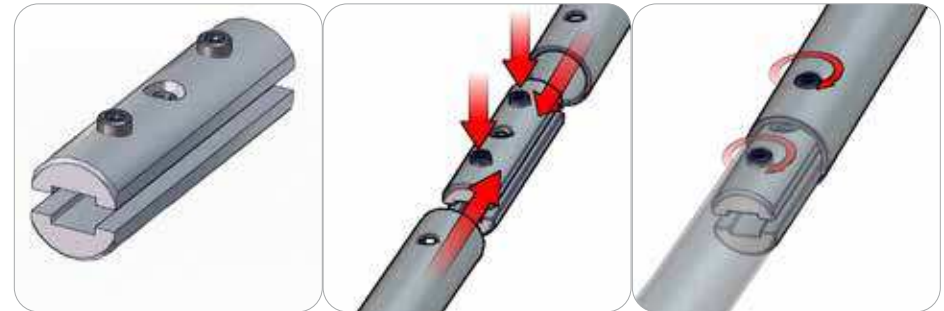

For spigot connections, compress the unlocked connector and slide into the tube lock access hole. Lock both screws carefully using your allen key tool. Be sure to lock securely, but do not over tighten. Do not force the connection and be careful with the tube edges, they may be sharp. To disassemble, unlocked connector press the snap button and pull apart.

## Connection Method 3: ES50-I-ES50-C-ASY



First, check if the connector ends compress. If they do not compress, use the allen key tool for turning the internal screw counter clockwise. Second, compress the connector end and slide it into the tube. Align the connector end button with the tube hole until it pops out. Third, use the allen key tool for turning the internal screw clockwise for a secure fit. Be sure to lock securely, but do not over tighten. Attach a stabilizing base plate to the connector with a M10 counter sink screw.