

IMPORTANT NOTE:

THIS TEMPLATE SHOWS PRINT LAYOUT ONLY.

EACH BANNER HAS ITS OWN UNIQUE ANGLE AND STRETCH WHEN ATTACHED TO THE FRAME.

IT IS HIGHLY RECOMMENDED TO KEEP TEXT AND LOGOS WITHIN THE SAFE AREA TO AVOID DISTORTION.

SEE PAGE 2 FOR REPRESENTATION OF POSITION ON FRAME

BANNER B: 26.75"W x 31.188"H

QTY: 2

BANNER C: 29.5"W x 28.5"H

QTY: 5

BANNER D: 26.75"W x 56"H



QTY: 1

BANNER G: 37"W x 39.5"H

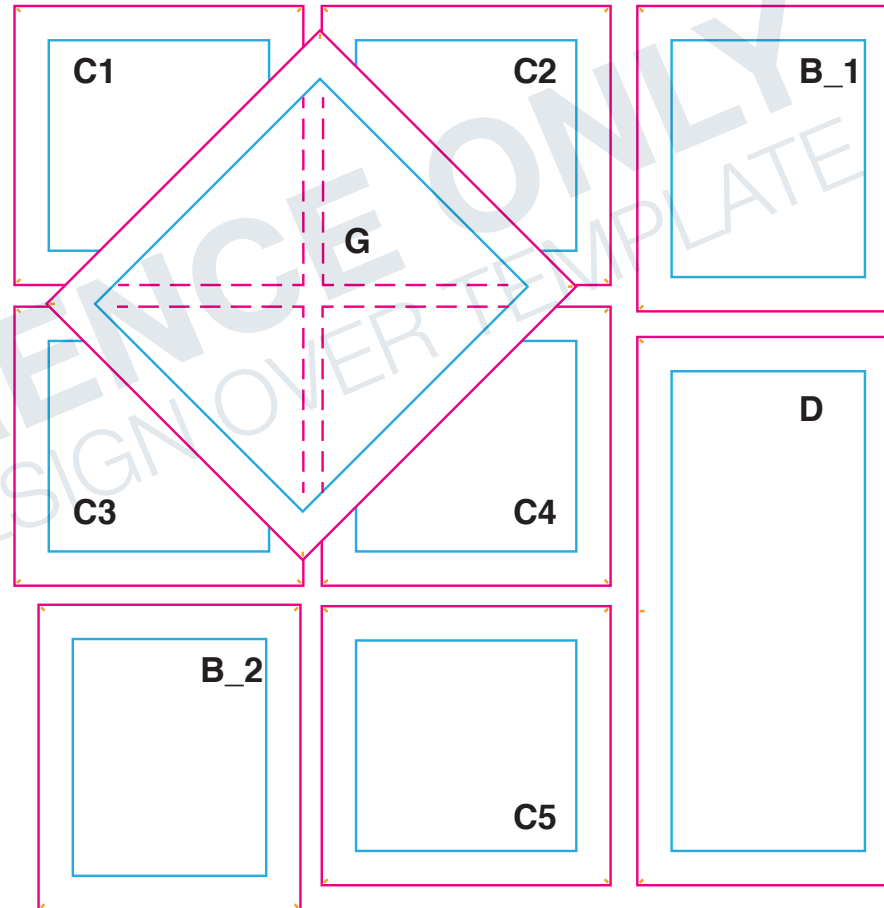
QTY: 1



TEMPLATE KEY

-  = FINISHED SIZE
-  = SAFE AREA
-  = PIN SLOT

FINISHED SIZE
See Following Pages

Area of art that is visible after finishing product. Background color/image should extend into the bleed area.

SAFE AREA
3.5" from finished edge

Recommended area to place artwork. Artwork within this area will be safe from variance in cut of finished edge /stitch line.

Using PMS colors in your art is recommended but an exact match cannot be guaranteed.

Dye-Sub products are printed CMYK (4 color) process from your art file.

FOR REFERENCE ONLY
PLEASE USE THE FULL SIZE TEMPLATES ON FOLLOWING PAGES TO SET UP ARTWORK

- All images must be embedded
- All fonts must be outlined.
- Shapes and fonts no smaller than .5" / 60pt.

ACCEPTABLE FILE FORMATS:



- Adobe Illustrator (.ai, .pdf, .eps)
- All Fonts Outlined
- Images Embedded



- Adobe Photoshop (.psd, .tif, .jpg)
- 200 DPI at 100% Scale

**EACH BANNER IS FABRICATED
TO FIT A SPECIFIC
ANGLE/POSITION ON THE
FRAME.**

**B=BACK
F=FRONT**

Item# 337122, 337112,
337101, 338090

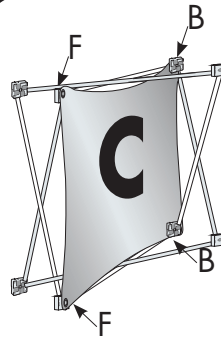

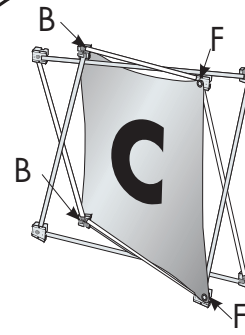

**THE 2 C PANELS
LEFT OF G PANEL**

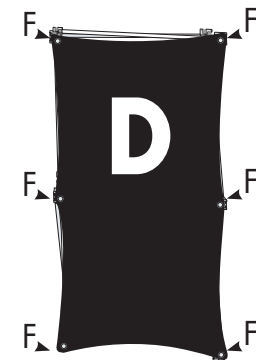
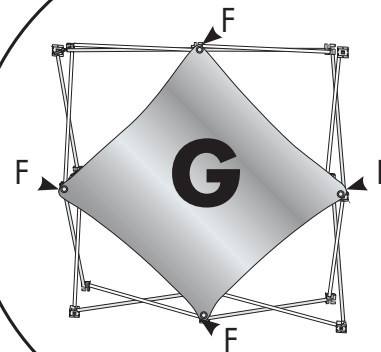
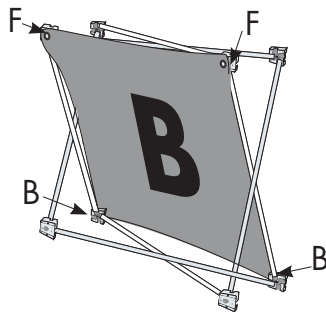
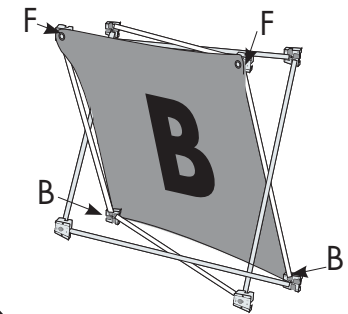
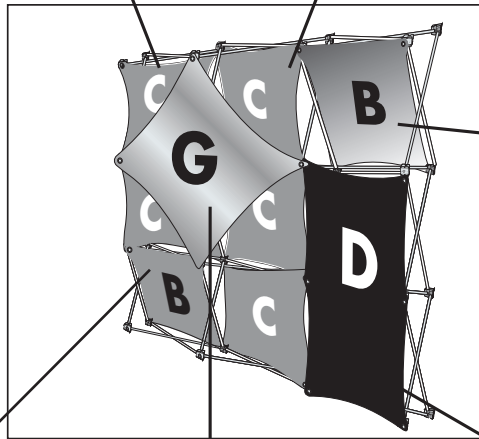

**THE 3 C PANELS
RIGHT OF G PANEL**



BANNER B

-  = FINISHED SIZE
-  = SAFE AREA
-  = PIN SLOT

FINISHED SIZE
26.75"W x 31.188"H

Area of art that is visible after finishing product. Background color/image should extend into the bleed area.

STITCH LINE
serged edges/pin slots

SAFE AREA
19.75"W x 24.188"H

Recommended area to place artwork. Artwork within this area will be safe from variance in cut of finished edge /stitch line.



Using PMS colors in your art is recommended but an exact match cannot be guaranteed.

Dye-Sub products are printed CMYK (4 color) process from your art file.

- All images must be embedded
- All fonts must be outlined.
- Shapes and fonts no smaller than .5" / 60pt.



BANNER C

-  = FINISHED SIZE
-  = SAFE AREA
-  = PIN SLOT

FINISHED SIZE
29.5"W x 28.5"H

Area of art that is visible after finishing product. Background color/image should extend into the bleed area.

STITCH LINE
serged edges/pin slots

SAFE AREA
22.5"W x 21.5"H

Recommended area to place artwork. Artwork within this area will be safe from variance in cut of finished edge /stitch line.



Using PMS colors in your art is recommended but an exact match cannot be guaranteed.

Dye-Sub products are printed CMYK (4 color) process from your art file.


- All images must be embedded
- All fonts must be outlined.
- Shapes and fonts no smaller than .5" / 60pt.



BANNER D

-  = FINISHED SIZE
-  = SAFE AREA
-  = PIN SLOT

FINISHED SIZE
26.75"W x 56"H
Area of art that is visible after finishing product. Background color/image should extend into the bleed area.

STITCH LINE
serged edges/pin slots



SAFE AREA
19.75"W x 49"H
Recommended area to place artwork. Artwork within this area will be safe from variance in cut of finished edge /stitch line.

Using PMS colors in your art is recommended but an exact match cannot be guaranteed.

Dye-Sub products are printed CMYK (4 color) process from your art file.

- All images must be embedded
- All fonts must be outlined.
- Shapes and fonts no smaller than .5" / 60pt.

BANNER G

-  = FINISHED SIZE
-  = SAFE AREA
-  = PIN SLOT

FINISHED SIZE
37"W x 39.5"H
Area of art that is visible after finishing product. Background color/image should extend into the bleed area.

STITCH LINE
serged edges/pin slots

SAFE AREA
30"W x 32.5"H
Recommended area to place artwork. Artwork within this area will be safe from variance in cut of finished edge, stitch line.

Using PMS colors in your art is recommended but an exact match cannot be guaranteed.

Dye-Sub products are printed CMYK (4 color) process from your art file.

- All images must be embedded
- All fonts must be outlined.
- Shapes and fonts no smaller than .5" / 60pt.



37"

-47° angle

39.5"