

Modulate Kit 10-01

MOD-10-01
MOD-10-01-OCE

Modulate™ Fabric Banner kits feature unique angles and shapes, are portable and easy to assemble. The aluminum tube frames feature snap-button and spigot connections and are coupled with a printed pillowcase fabric graphic that slips over the frame and zips at the bottom. Each individual frame of the kit comes in a durable, portable carry bag/packed in a box. Each kit has an optional upgrade for hard cases.



We are continually improving and modifying our product range and reserve the right to vary the specifications without prior notice. All dimensions and weights quoted are approximate and we accept no responsibility for variance. E&OE. See Graphic Templates for graphic bleed specifications.

features and benefits:

- Premium aluminum tube frame with spigot and snap button assembly
- Easy to store and ship
- Quick to set up
- Weighted feet for added stability
- Comes with carry bag and box
- Zipper pillowcase fabric graphics
- Lifetime limited hardware warranty against manufacturer defects

dimensions:

Hardware	Graphic
<p>Assembled unit: 110.83" w x 96" h x 22.54" d 2815mm(w) x 2438mm(h) x 573mm(d)</p> <p>Approximate assembled weight: 36 lbs / 16 kgs</p>	<p>Refer to related graphic template for more information.</p> <p>Visit: www.exhibitors-handbook.com/graphic-templates</p>
<p>Shipping</p> <p>Packing Option 1: 3 Boxes</p> <p>Shipping box dimensions: Box Size; 48" l x 11" h x 4" d 1219mm(l) x 279mm(h) x 102mm(d)</p> <p>Approximate total shipping weight: 42 lbs / 19 kgs</p>	<p>Qty. 3</p>
<p>Packing Option 2: MOD-10-01-OCE 1 OCE Case</p> <p>Shipping case dimensions: OCE: Expandable case length (l) may vary 40" - 66" l x 18" h x 18" d 1016mm-1677mm(l) x 458mm(h) x 458mm(d)</p> <p>Approximate total shipping weight: 72 lbs / 33 kgs</p>	<p>additional information:</p> <p>Graphic material: dye-sublimation zipper pillowcase fabric</p> <p>When included in a larger kit, a different packaging solution will be listed to accommodate all contents of the kit. Individual packaging no longer provided.</p>

Included In Your Kit



MOD-FRM-04 x1



MOD-FRM-06 x1



MOD-FRM-03 x1

Suggested Kit Layout

MOD-10-01

- MOD-FRM-03
- MOD-FRM-06
- MOD-FRM-04

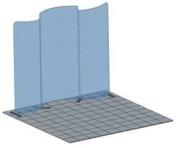
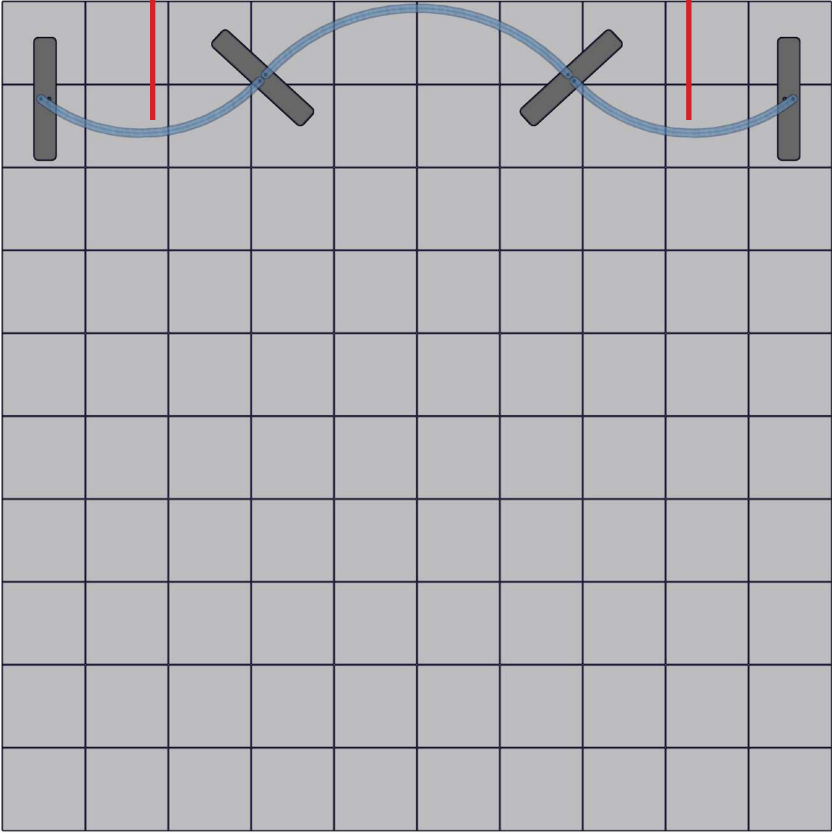
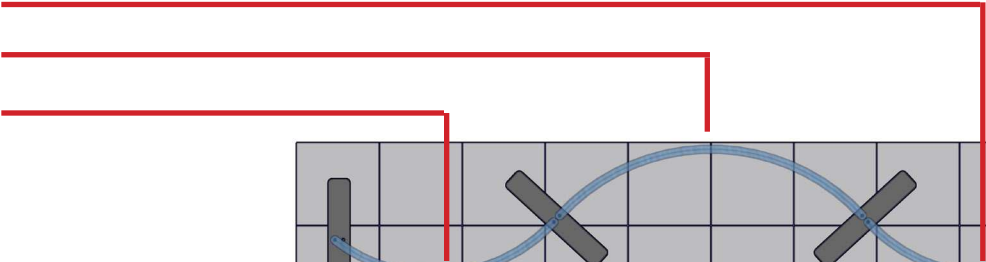

Modulate Frame 03

MOD-FRM-03

Modulate™ Fabric Banners feature unique angles and shapes, are portable and easy to assemble. Choose from multiple frame shapes and connect them to design your own combinations. The aluminum tube frames feature snap-button and spigot connections and are coupled with a printed pillowcase fabric graphic that slips over the frame and zips at the bottom. Two linking clips are included to connect banner frames together and universal feet connect the tube frames at the bottom of the display. Each frame comes in a durable, portable carry bag.



We are continually improving and modifying our product range and reserve the right to vary the specifications without prior notice. All dimensions and weights quoted are approximate and we accept no responsibility for variance. E&OE. See Graphic Templates for graphic bleed specifications.

features and benefits:

- Premium aluminum tube frame with spigot and snap button assembly
- Easy to store and ship
- Quick to set up
- Weighted feet for added stability
- Comes with carry bag and box
- Zipper pillowcase fabric graphics
- Lifetime limited hardware warranty against manufacturer defects

dimensions:

Hardware	Graphic
Assembled unit: 35" w x 96" h x 17.72" d 889mm(w) x 2438mm(h) x 450mm(d) Approximate assembled weight: 12 lbs / 5 kgs	Refer to related graphic template for more information. Visit: www.exhibitors-handbook.com/graphic-templates
Shipping	
Packing box(es): 1 Box Box size: 48" l x 11" h x 4" d Approximate total shipping weight: (includes boxes & graphics): 14 lbs / 6 kgs	
additional information:	
Graphic material: dye-sublimation zipper pillowcase fabric	
When included in a larger kit, a different packaging solution will be listed to accommodate all contents of the kit. Individual packaging no longer provided.	

Included In Your Kit

Tools, Components, & Connectors



ALLEN KEY SET x1



ES30 x4



PLT-BP-LN114-S5-450 x2



TC-30-A x1



ES30-90B x2



LN114-SCRW x2



MOD-CLP-180 x2

Graphics

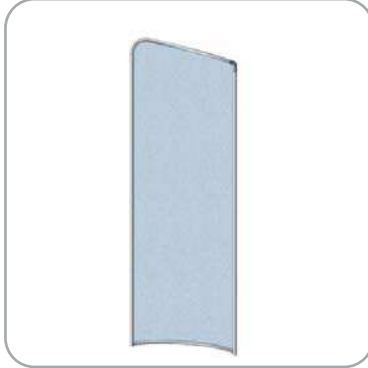

MOD-FRM-03-LT-G x1

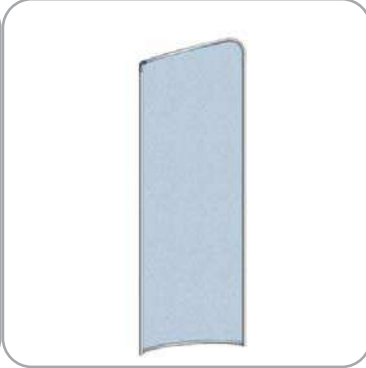

MOD-FRM-03-RT-G x1

Included In Your Kit



MOD-FRM-03-T1 x1



MOD-FRM-03-T2 x3



MOD-FRM-03-T4 x1



MOD-FRM-03-T3 x1



MOD-FRM-03-T11 x1

Tubes

Exploded View

MOD-FRM-03

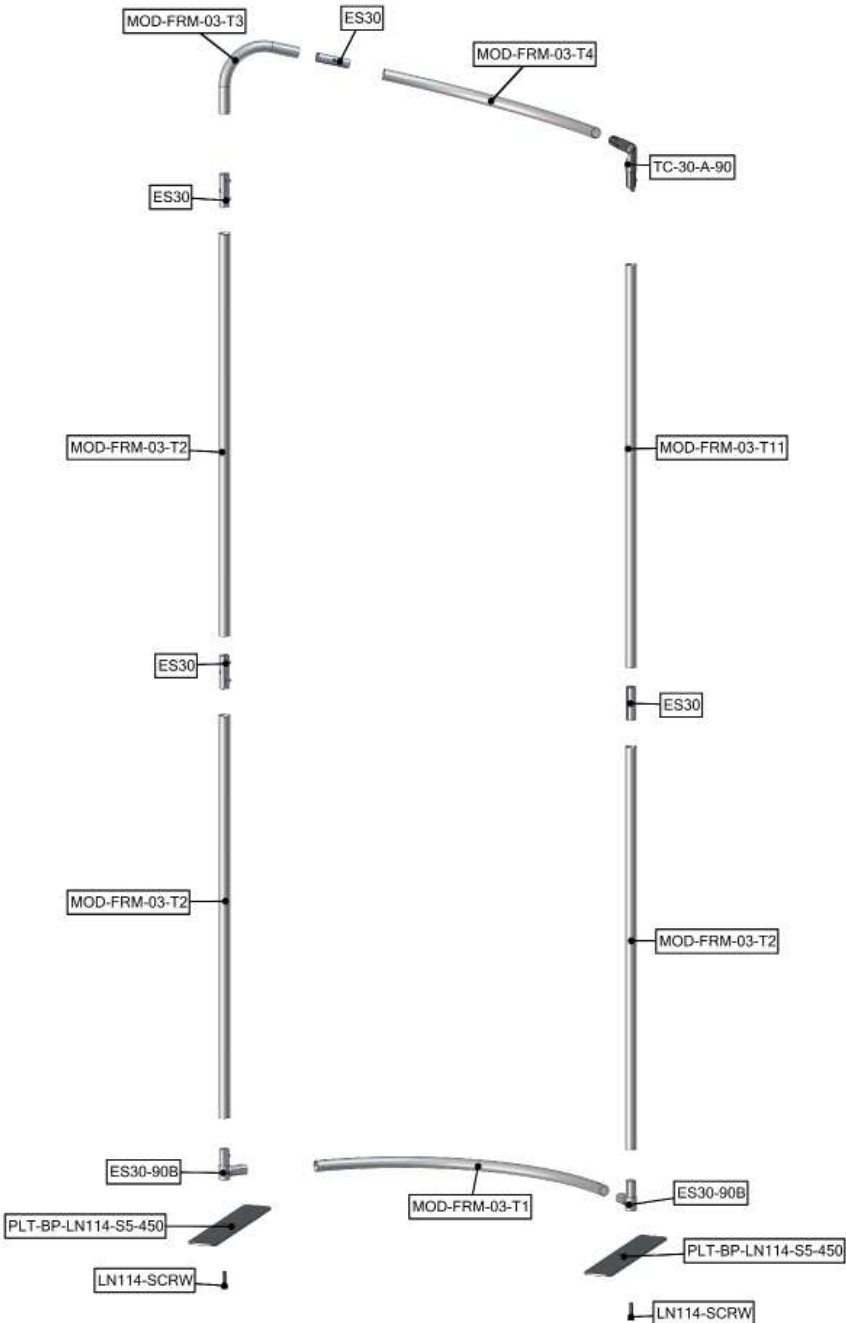

Labeling Diagram

MOD-FRM-03

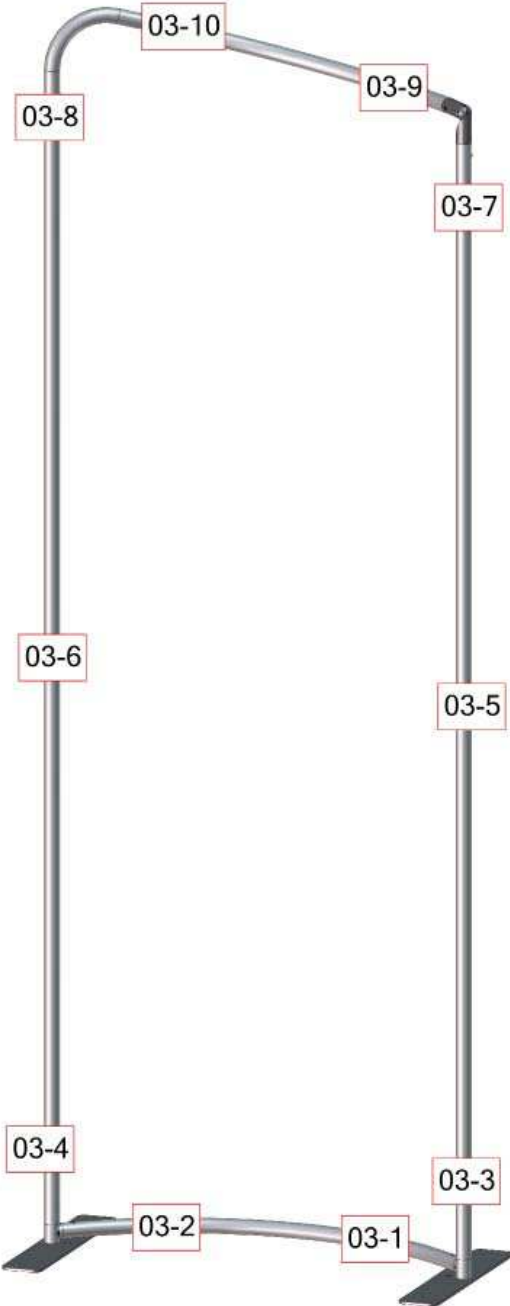

Connection Methods

Formulate™ structures use a number of different yet simple connection methods. Your kit will include one or more of the connection methods shown below. Steps within the Kit Assembly will reference a specific method for each connection point.

Connection Method 1: ES30 / ES50 / ES75

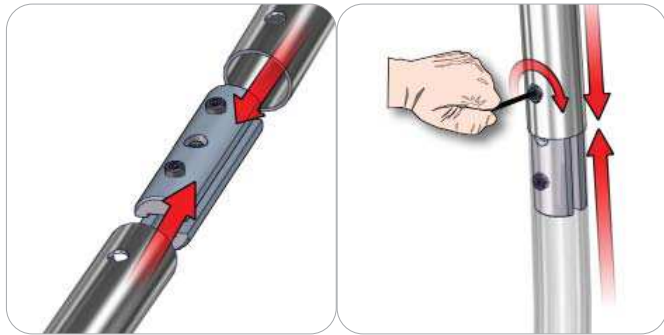

Compress the unlocked connector and slide one tube onto each end. Lock both screws carefully using your allen key tool. Be sure to lock securely, but do not overtighten.

Connection Method 2: Snap Buttons & Swage

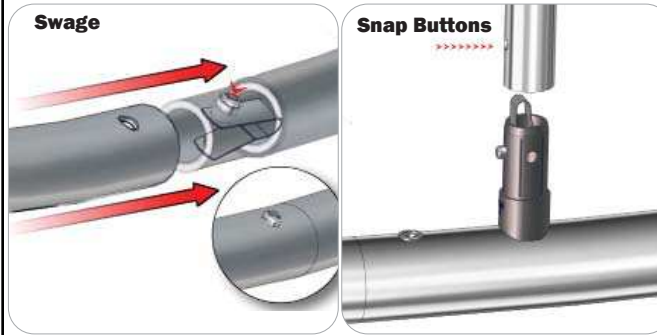

Locate the snap button on the connector or swage tube. Locate the hole on the corresponding tube. Press the snap button with your thumb and slide the tube and connector together so that the snap button snaps fully into the lock hole. To disassemble, press the snap button and pull apart.

Connection Method 3: ES30-90B / ES30-I / ES30-C

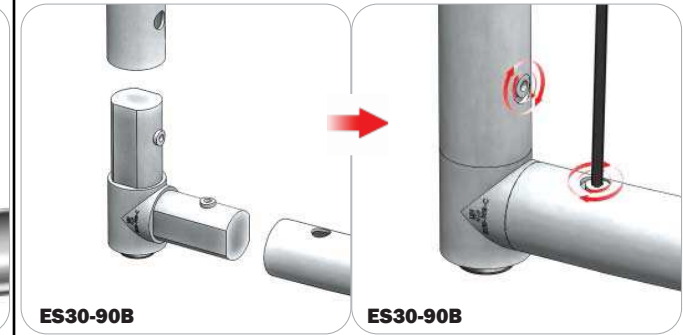

Compress one unlocked end of the connector and slide it through one tube end. Compress the other end of the connector and slide the second tube on. Lock both screws carefully using your allen key tool. Be sure to lock securely, but do not overtighten.

Connection Method 4: Linking Clips

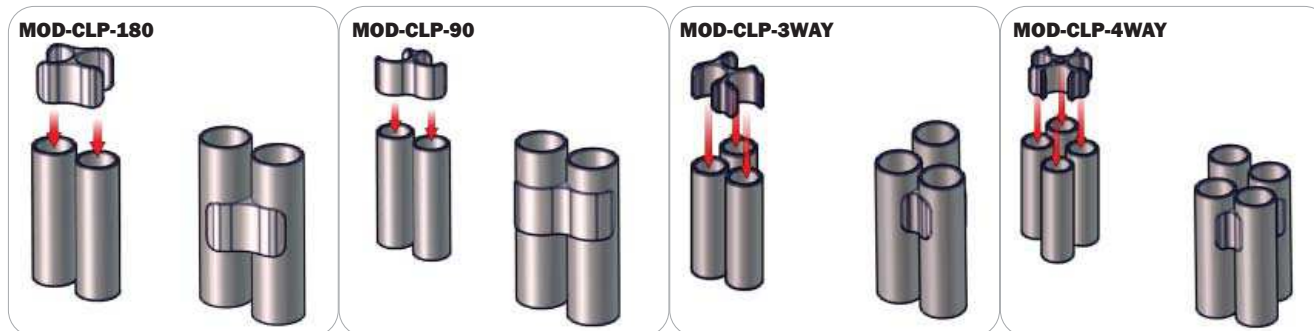

Be sure to fully assemble all frames with fabric pillowcase before using clips. Simply snap the frames into the clips and adjust until frames are aligned as desired.

Connection Method 5: PLT-BP-LN114-S5-450

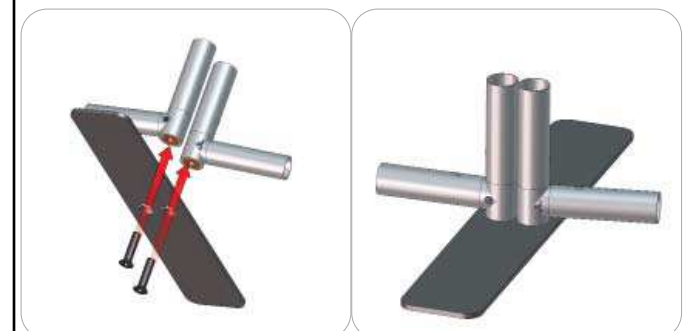

Join both frames to the stabilizing base. Fasten both screws carefully using your allen key tool. Be sure to fasten securely, but do not overtighten.

Kit Assembly

Step by Step

Step 1.

Gather the components necessary for assembling the frame. Assemble in the order the Labeling Diagram instructs. Lock your connectors into place using the provided allen key set.

Please reference Connection Methods 1, 2 and 3 for more details.

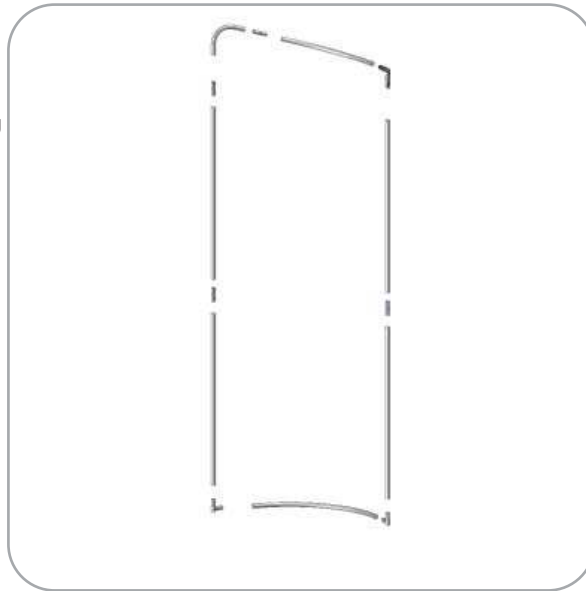

Step 2.

Locate your pillowcase graphic. With the pillowcase unzipped, encase the frame by covering the frame from top to bottom. Zipper at the bottom.

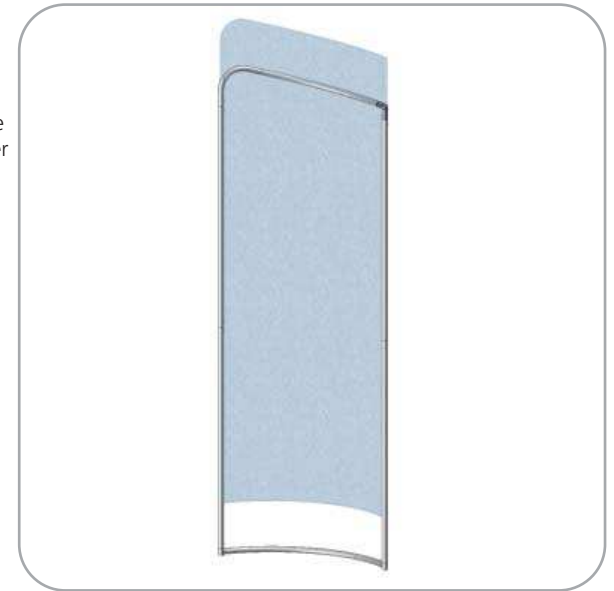

Step 3.

Locate the Stabilizing Bases; LN114-S5. Attach the foot to the bottom of the frame. Use the allen key tool provided to lock the bases to the ES30-90B's.

Setup Complete.

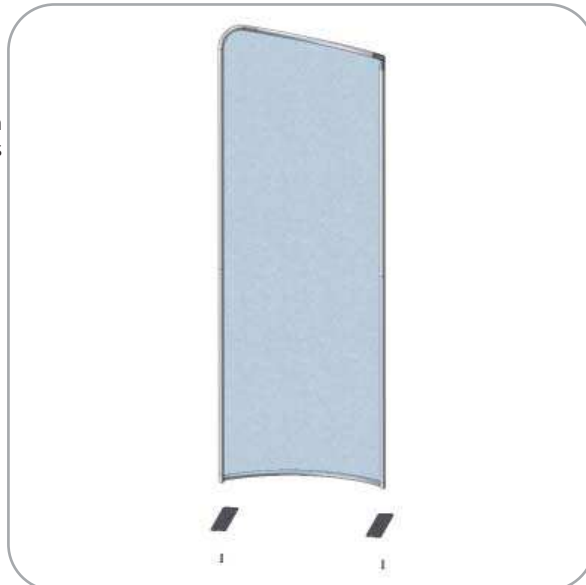

Modulate Frame 04

MOD-FRM-04

Modulate™ Fabric Banners feature unique angles and shapes, are portable and easy to assemble. Choose from multiple frame shapes and connect them to design your own combinations. The aluminum tube frames feature snap-button and spigot connections and are coupled with a printed pillowcase fabric graphic that slips over the frame and zips at the bottom. Two linking clips are included to connect banner frames together and universal feet connect the tube frames at the bottom of the display. Each frame comes in a durable, portable carry bag.



features and benefits:

- Premium aluminum tube frame with spigot and snap button assembly
- Easy to store and ship
- Quick to set up
- Weighted feet for added stability
- Comes with carry bag and box
- Zipper pillowcase fabric graphics
- Lifetime limited hardware warranty against manufacturer defects

dimensions:

Hardware	Graphic
<p>Assembled unit: 35" w x 96" h x 17.72" d 889mm(w) x 2438mm(h) x 450mm(d)</p> <p>Approximate assembled weight: 12 lbs / 5 kgs</p>	<p>Refer to related graphic template for more information.</p> <p>Visit: www.exhibitors-handbook.com/graphic-templates</p>
Shipping	
<p>Packing box(es): 1 Box</p> <p>Box size: 48" l x 11" h x 4" d</p> <p>Approximate total shipping weight: (includes boxes & graphics): 14 lbs / 6 kgs</p>	
	additional information:
	<p>Graphic material: dye-sublimation zipper pillowcase fabric</p> <p>When included in a larger kit, a different packaging solution will be listed to accommodate all contents of the kit. Individual packaging no longer provided.</p>

We are continually improving and modifying our product range and reserve the right to vary the specifications without prior notice. All dimensions and weights quoted are approximate and we accept no responsibility for variance. E&OE. See Graphic Templates for graphic bleed specifications.

Included In Your Kit

Tools, Components, & Connectors



ALLEN KEY SET x1



ES30 x4

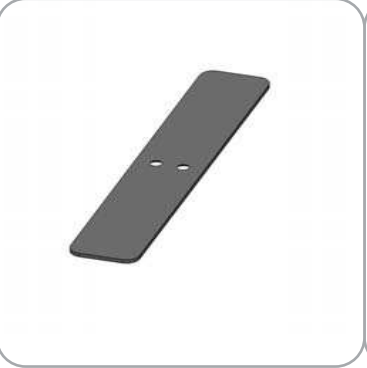

PLT-BP-LN114-S5-450 x2



TC-30-A x1



ES30-90B x2



LN114-SCRW x2



MOD-CLP-180 x2

Graphics

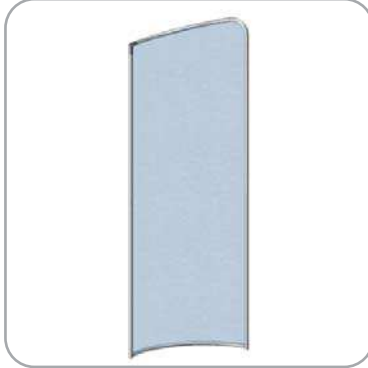

MOD-FRM-04-RT-G x1

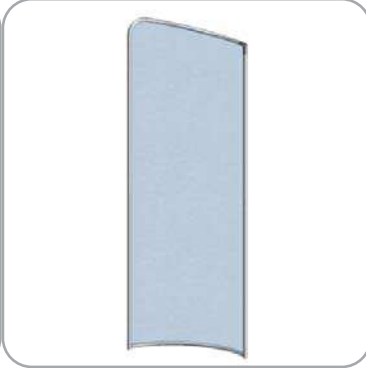

MOD-FRM-04-LT-G x1

Included In Your Kit



MOD-FRM-03-T1 x1



MOD-FRM-03-T2 x3



MOD-FRM-03-T9 x1



MOD-FRM-03-T10 x1



MOD-FRM-03-T11 x1

Tubes

Exploded View

MOD-FRM-04

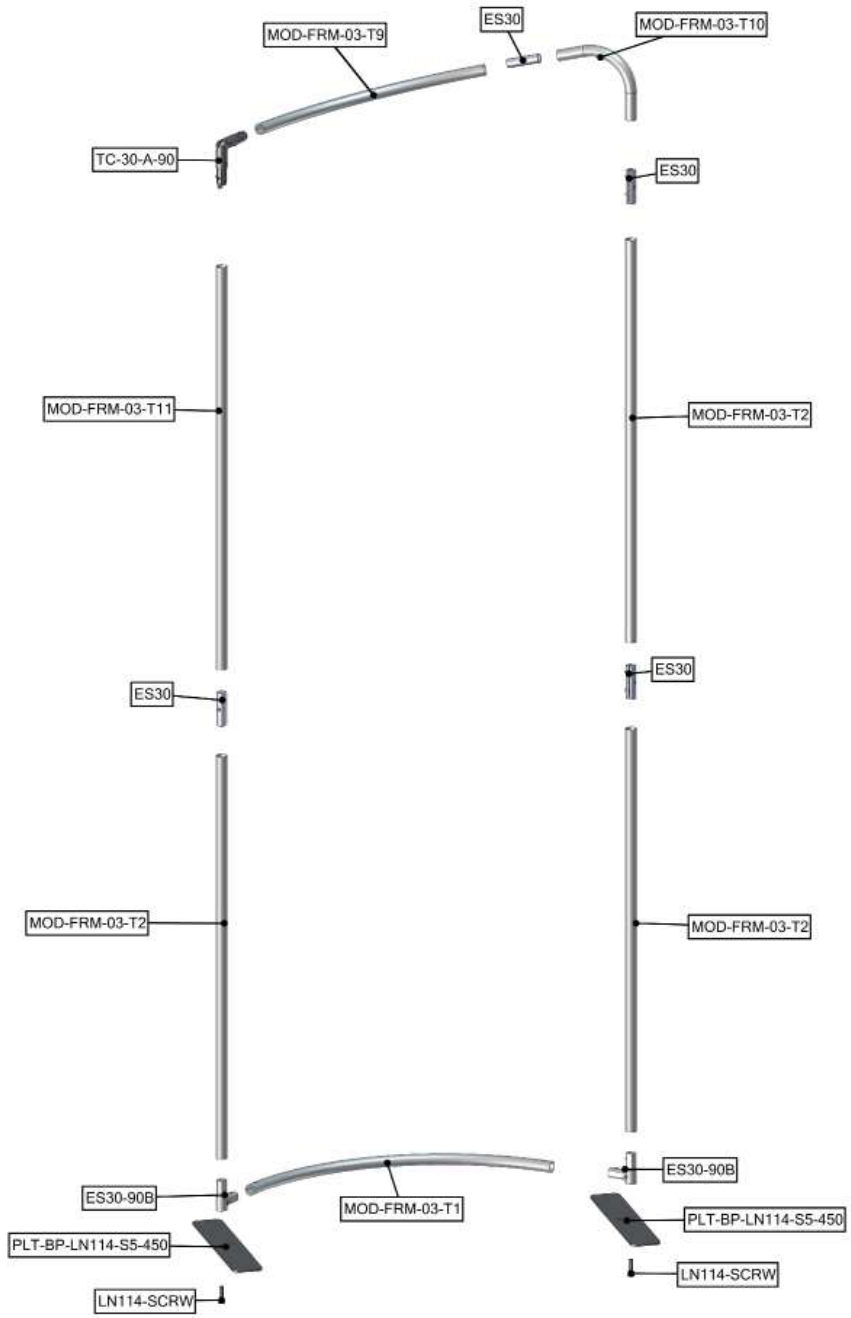

Labeling Diagram

MOD-FRM-04

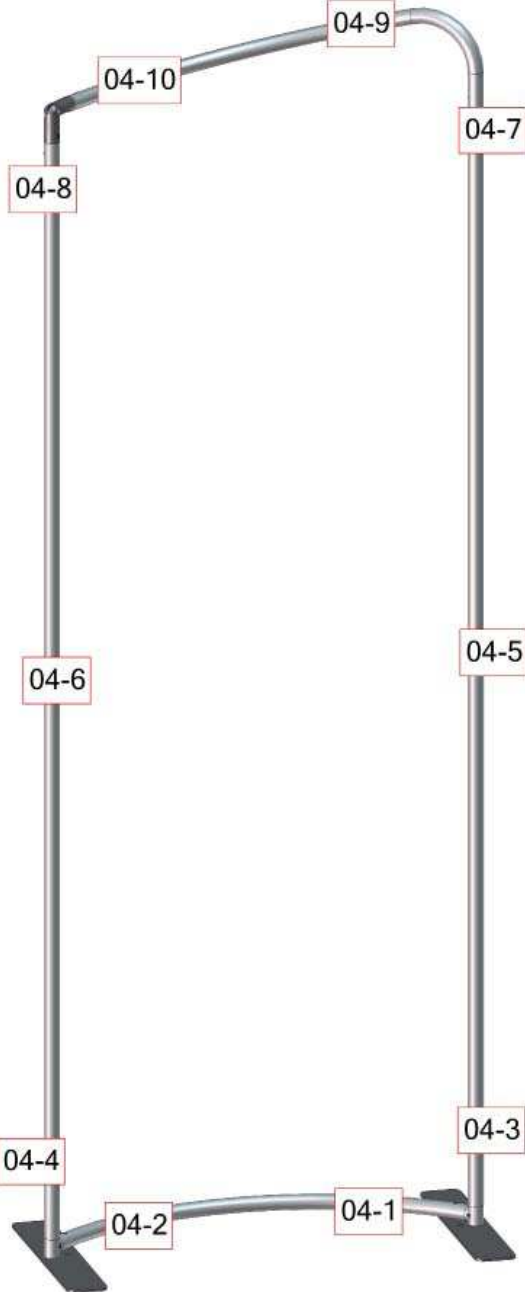

Connection Methods

Formulate™ structures use a number of different yet simple connection methods. Your kit will include one or more of the connection methods shown below. Steps within the Kit Assembly will reference a specific method for each connection point.

Connection Method 1: ES30 / ES50 / ES75

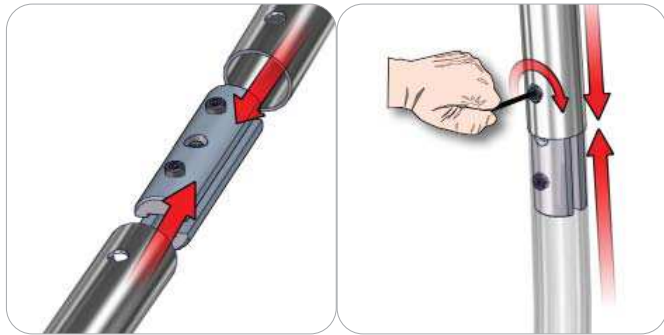

Compress the unlocked connector and slide one tube onto each end. Lock both screws carefully using your allen key tool. Be sure to lock securely, but do not overtighten.

Connection Method 2: Snap Buttons & Swage

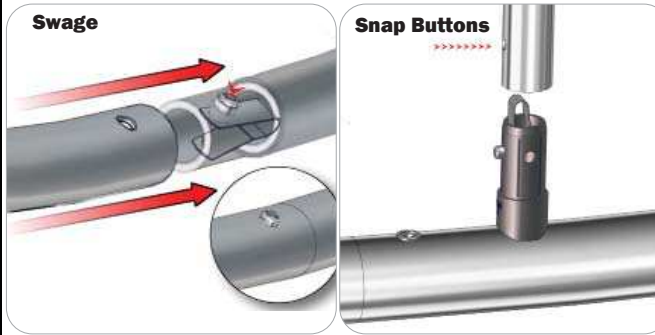

Locate the snap button on the connector or swage tube. Locate the hole on the corresponding tube. Press the snap button with your thumb and slide the tube and connector together so that the snap button snaps fully into the lock hole. To disassemble, press the snap button and pull apart.

Connection Method 3: ES30-90B / ES30-I / ES30-C

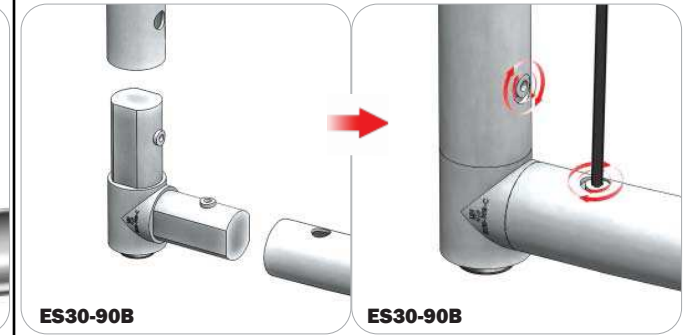

Compress one unlocked end of the connector and slide it through one tube end. Compress the other end of the connector and slide the second tube on. Lock both screws carefully using your allen key tool. Be sure to lock securely, but do not overtighten.

Connection Method 4: Linking Clips

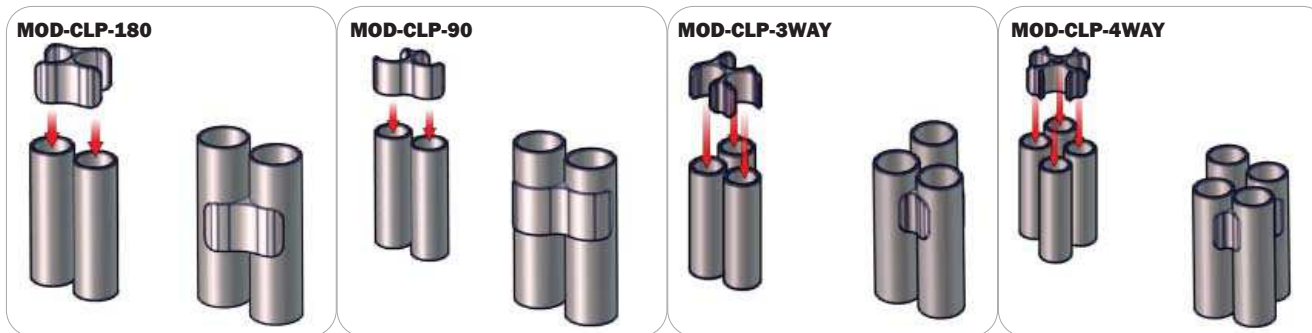

Be sure to fully assemble all frames with fabric pillowcase before using clips. Simply snap the frames into the clips and adjust until frames are aligned as desired.

Connection Method 5: PLT-BP-LN114-S5-450

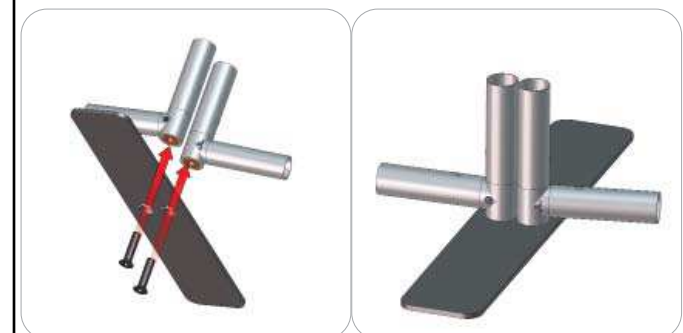

Join both frames to the stabilizing base. Fasten both screws carefully using your allen key tool. Be sure to fasten securely, but do not overtighten.

Kit Assembly

Step by Step

Step 1.

Gather the components necessary for assembling the frame. Assemble in the order the Labeling Diagram instructs. Lock your connectors into place using the provided allen key set.

Please reference Connection Methods 1, 2 and 3 for more details.

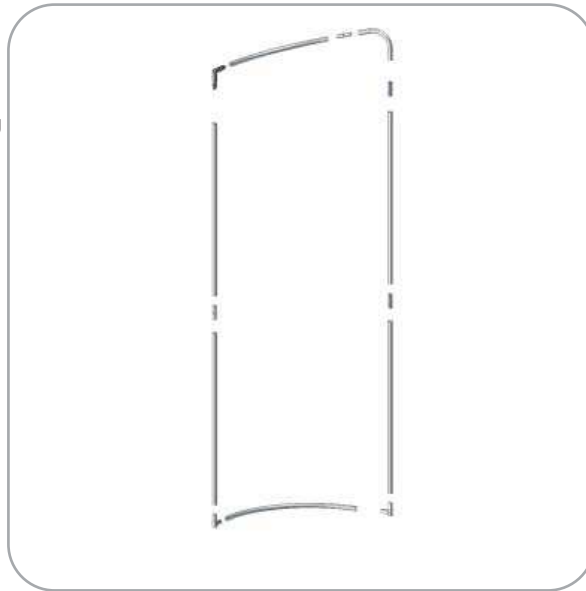

Step 2.

Locate your pillowcase graphic. With the pillowcase unzipped, encase the frame by covering the frame from top to bottom. Zipper at the bottom.



Step 3.

Locate the Stabilizing Bases; LN114-S5. Attach the foot to the bottom of the frame. Use the allen key tool provided to lock the bases to the ES30-90B's.

Setup Complete.

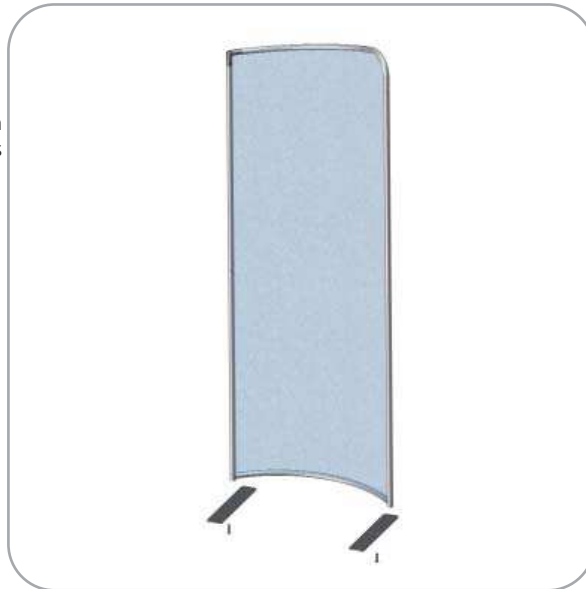

Modulate Frame 06

MOD-FRM-06

Modulate™ Fabric Banners feature unique angles and shapes, are portable and easy to assemble. Choose from multiple frame shapes and connect them to design your own combinations. The aluminum tube frames feature snap-button and spigot connections and are coupled with a printed pillowcase fabric graphic that slips over the frame and zips at the bottom. Two linking clips are included to connect banner frames together and universal feet connect the tube frames at the bottom of the display. Each frame comes in a durable, portable carry bag.



We are continually improving and modifying our product range and reserve the right to vary the specifications without prior notice. All dimensions and weights quoted are approximate and we accept no responsibility for variance. E&OE. See Graphic Templates for graphic bleed specifications.

features and benefits:

- Premium aluminum tube frame with spigot and snap button assembly
- Easy to store and ship
- Quick to set up
- Weighted feet for added stability
- Comes with carry bag and box
- Zipper pillowcase fabric graphics
- Lifetime limited hardware warranty against manufacturer defects

dimensions:

Hardware	Graphic
Assembled unit: 45.74" w x 96" h x 17.72" d 1162mm(w) x 2438mm(h) x 450mm(d) Approximate assembled weight: 12 lbs / 5 kgs	Refer to related graphic template for more information. Visit: www.exhibitors-handbook.com/graphic-templates
Shipping	
Packing box(es): 1 Boxes Box size: 48" l x 11" h x 4" d Approximate total shipping weight: (includes boxes & graphics): 14 lbs / 6 kgs	
additional information:	
Graphic material: dye-sublimation zipper pillowcase fabric	
When included in a larger kit, a different packaging solution will be listed to accommodate all contents of the kit. Individual packaging no longer provided.	

Included In Your Kit

Tools, Components, & Connectors



ALLEN KEY SET x1



ES30 x2

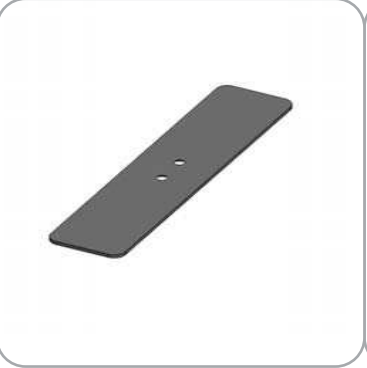

PLT-BP-LN114-S5-450 x2



TC-30-A x2



ES30-90B x2



LN114-SCRW x2



MOD-CLP-180 x2

Graphics



MOD-FRM-06-CV-G x1



MOD-FRM-06-CC-G x1

Included In Your Kit



MOD-FRM-06-T1 x1



MOD-FRM-06-T2 x2



MOD-FRM-06-T3 x2



MOD-FRM-06-T4 x1

Tubes

Exploded View

MOD-FRM-06

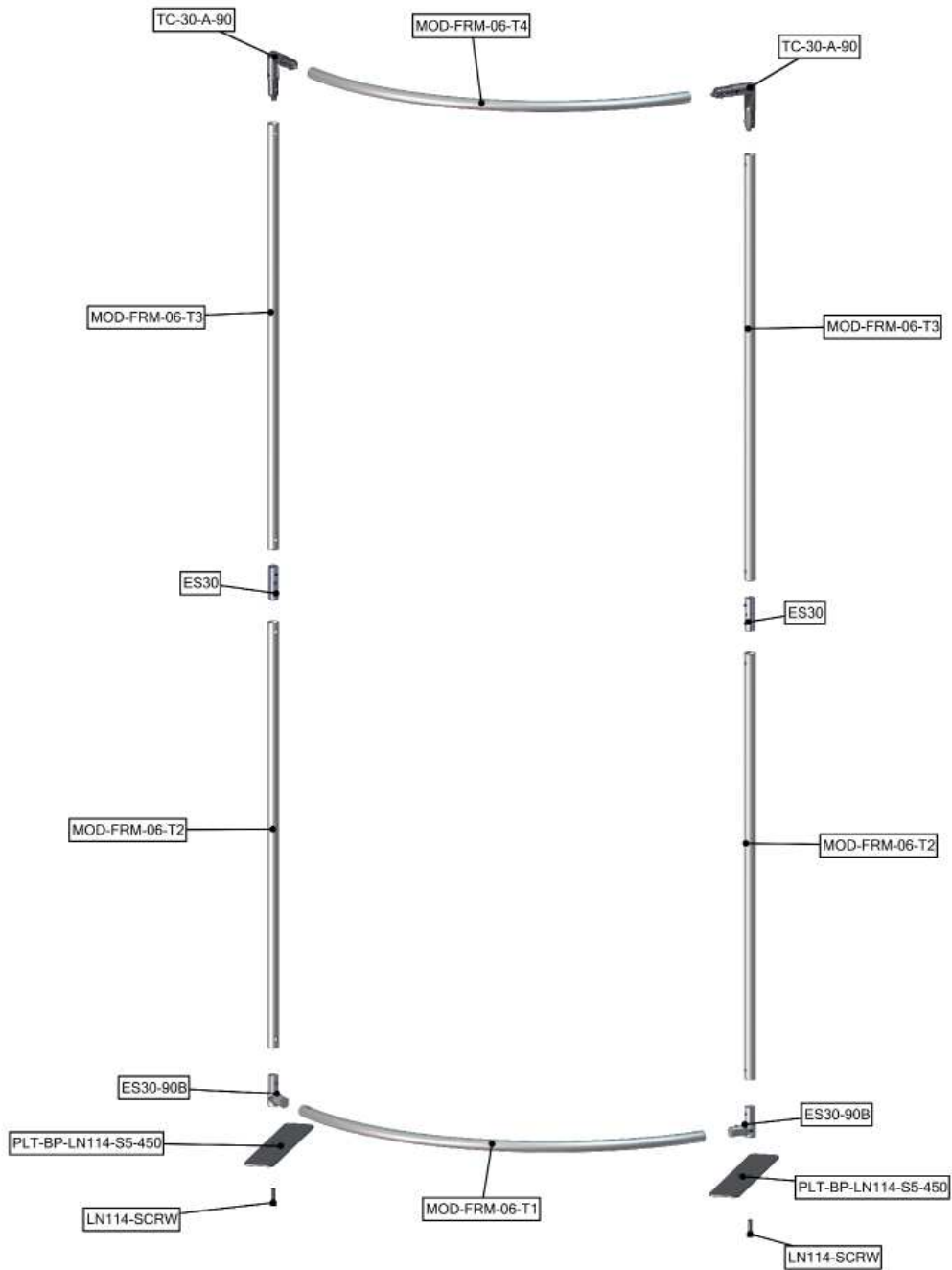

Labeling Diagram

MOD-FRM-06

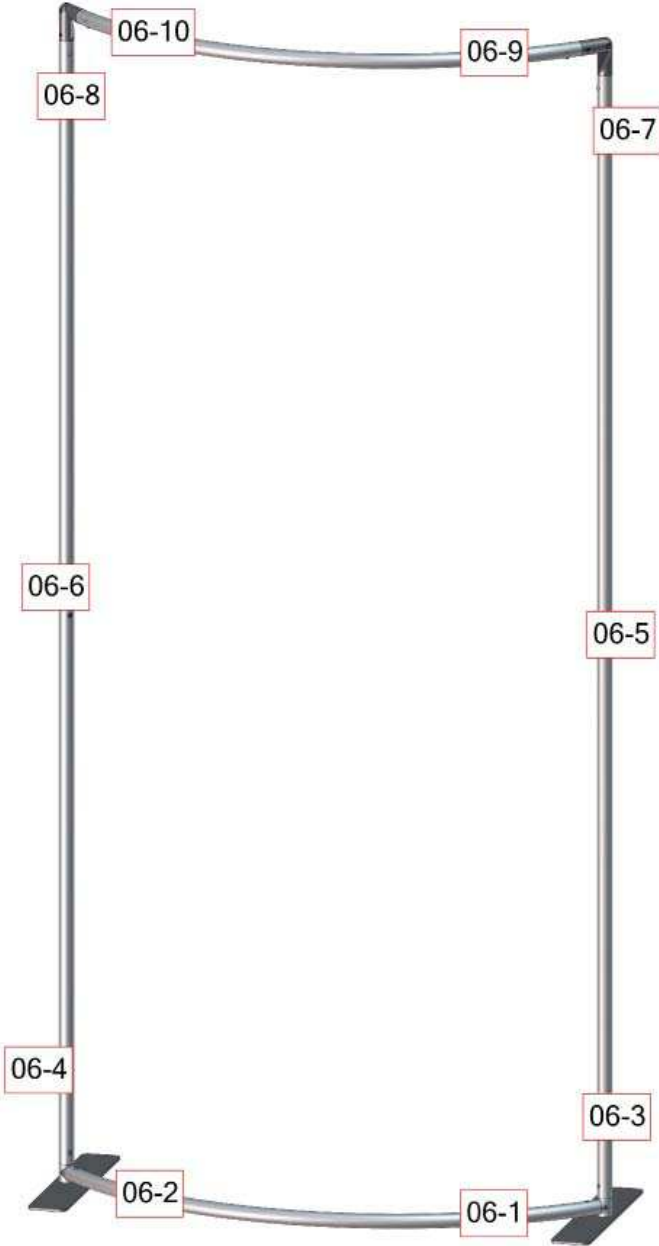

Connection Methods

Formulate™ structures use a number of different yet simple connection methods. Your kit will include one or more of the connection methods shown below. Steps within the Kit Assembly will reference a specific method for each connection point.

Connection Method 1: ES30 / ES50 / ES75

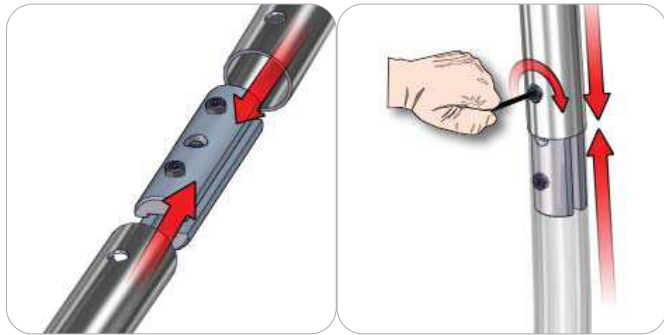

Compress the unlocked connector and slide one tube onto each end. Lock both screws carefully using your allen key tool. Be sure to lock securely, but do not overtighten.

Connection Method 2: Snap Buttons & Swage

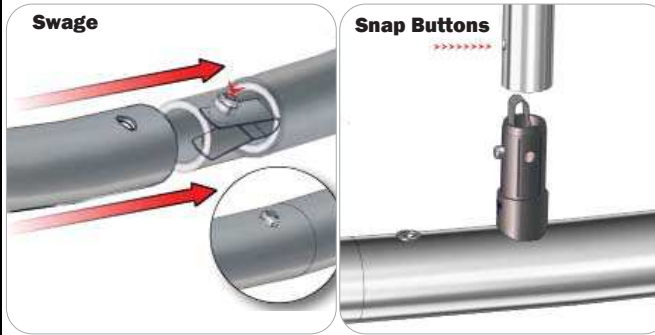

Locate the snap button on the connector or swage tube. Locate the hole on the corresponding tube. Press the snap button with your thumb and slide the tube and connector together so that the snap button snaps fully into the lock hole. To disassemble, press the snap button and pull apart.

Connection Method 3: ES30-90B / ES30-I / ES30-C

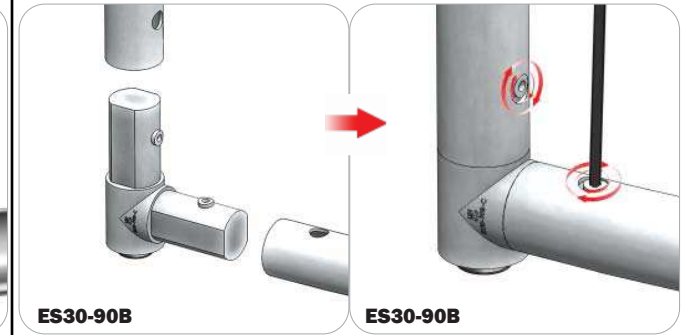

Compress one unlocked end of the connector and slide it through one tube end. Compress the other end of the connector and slide the second tube on. Lock both screws carefully using your allen key tool. Be sure to lock securely, but do not overtighten.

Connection Method 4: Tube Clamps

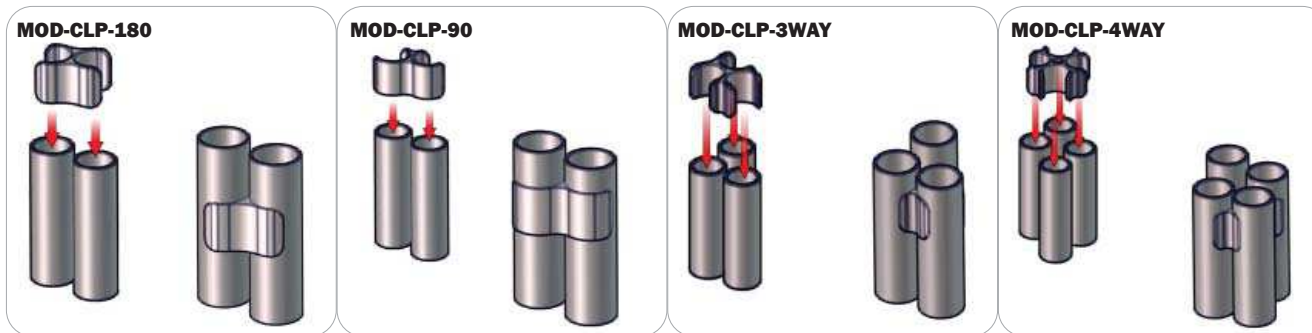

Be sure to fully assemble all frames with fabric pillowcase before using clips. Simply snap the frames into the clips and adjust until frames are aligned as desired.

Connection Method 5: PLT-BP-LN114-S5-450

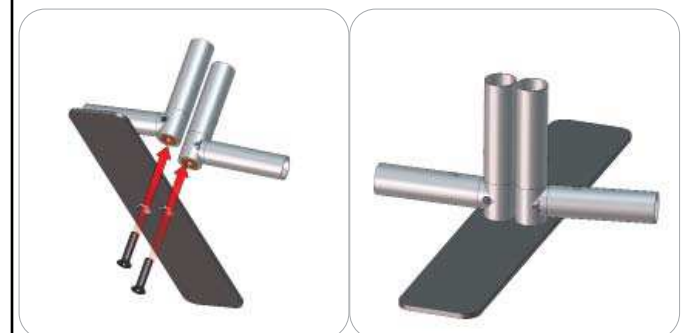

Join both frames to the stabilizing base. Fasten both screws carefully using your allen key tool. Be sure to fasten securely, but do not overtighten.

Kit Assembly

Step by Step

Step 1.

Gather the components necessary for assembling the frame. Assemble in the order the Labeling Diagram instructs. Lock your connectors into place using the provided allen key set.

Please reference Connection Methods 1, 2 and 3 for more details.

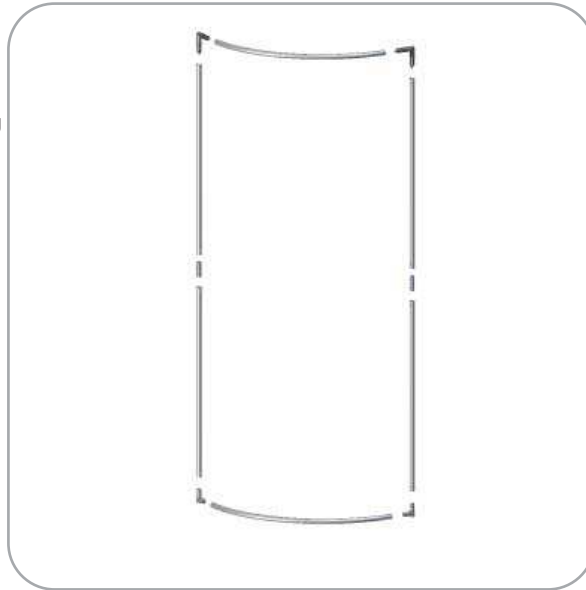

Step 2.

Locate your pillowcase graphic. With the pillowcase unzipped, encase the frame by covering the frame from top to bottom. Zipper at the bottom.



Step 3.

Locate the Stabilizing Bases; LN114-S5. Attach the foot to the bottom of the frame. Use the allen key tool provided to lock the bases to the ES30-90B's.

Setup Complete.

