

▶ 4 FOOT HOUSE

ASSEMBLY INSTRUCTIONS

SETUP ▼

THIS ASSEMBLY REQUIRES TWO OR MORE PEOPLE

- 1) Position the left and right sides of the Bottom Frame with snaps facing outward and connect together by inserting pipes with buttons (A, B) into fittings with button holes.
- 2) Clip counter legs (C) to the bottom frame. If your 4 Foot House is equipped with an optional undercounter shelf attach the counter support cross brace (D).
- 3) Assemble the top counter cross brace by inserting the pipe with button (E) into the fitting with the button hole. Attach the cross brace by inserting the fittings into the counter legs (C) and clipping to the outer frame.

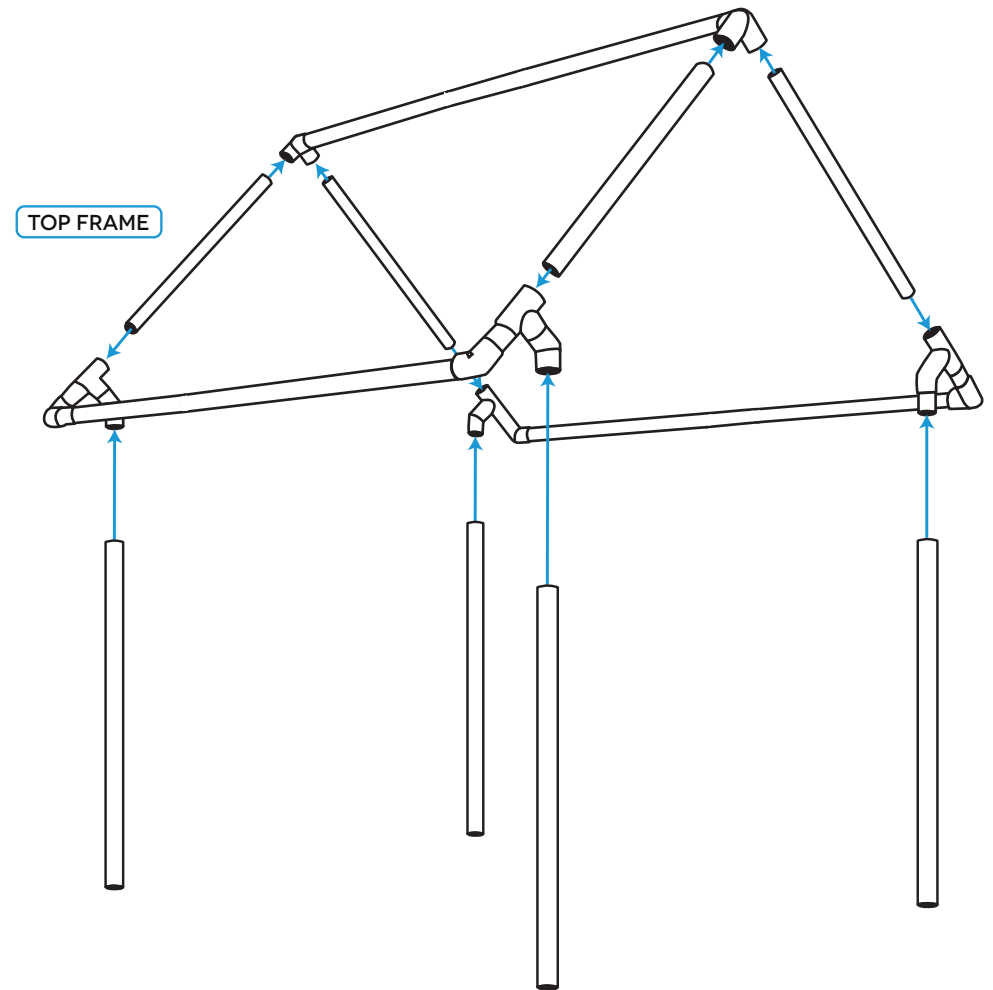
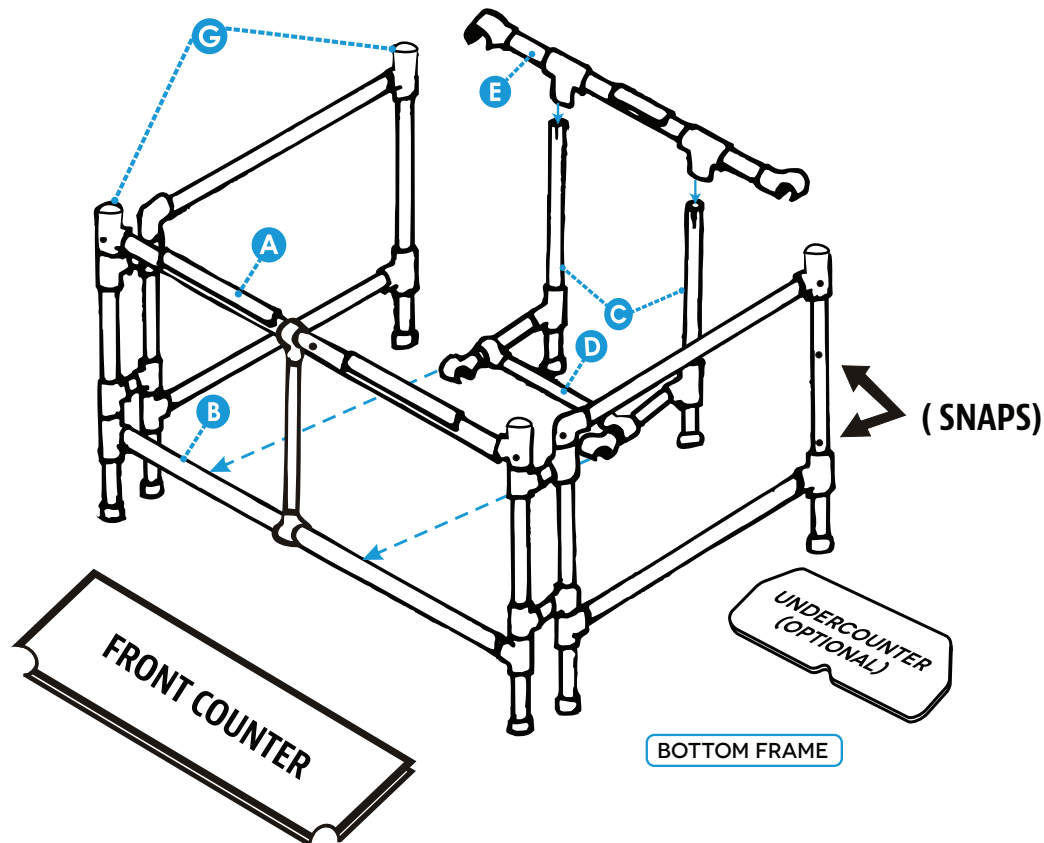

- 4) Align counters, hook & loop side down, making sure the hole aligns with the outside front corner of the frame. Place the hole over the corner frame fitting, and press down firmly to secure.
- 5) Assemble the Top Frame as shown in the diagram above, paying special attention to positioning of each distinctive part.
- 6) Place assembled house top onto the four vertical support poles.
- 7) Place the vinyl house top onto the assembled Top Frame and snap into place.
- 8) Attach the Top Frame to the Bottom Frame by lifting the vertical support poles and inserting into the frame sockets labeled ().
- 9) Snap the vinyl skirt onto the bottom frame, starting from one end.

▶ PRODUCT CARE INSTRUCTIONS

Thank you for purchasing a Great Gazebo, Inc. product. We have used the highest quality materials and manufacturing standards. To ensure that you obtain the best possible results, please read these instructions thoroughly and save for future reference.

STORAGE & TRANSPORT ▼

Store the vinyl House Top and Skirt in the included drawstring bag.



VINYL

To store the 4 Foot House Top : First, fold in half along top seam, as shown below. Next, fold the outer triangles inward along the seams. Finally, roll the 4 Foot House Top from edge to edge.

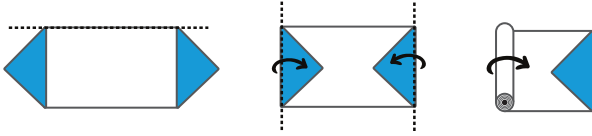

To store the 4 Foot Skirt: While in an indoor location with a clean, dry floor, roll the skirt on the floor with the vinyl side out and the cloth side in (**FIG. A**). Otherwise, to keep the 4 Foot Skirt off of the ground, simply roll the skirt with the vinyl side in as you are unsnapping the skirt from the bottom frame (**FIG. B**).

CAUTION! Do not drag vinyl on ground. Severe abrasion will damage the vinyl and graphics.

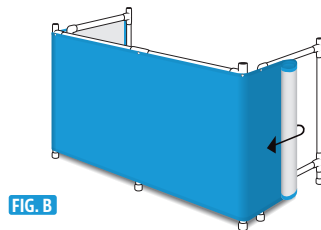
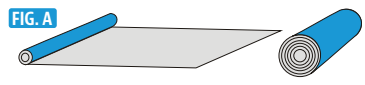

STORAGE & TRANSPORT ▼

FRAME



RUBBER Mallet



TOP COUNTER BRACE

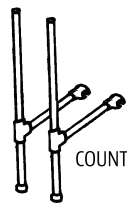

COUNTER LEGS

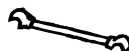

BOTTOM COUNTER BRACE



CASH BOX SHELF (OPTIONAL)



CASE FOR PIPE AND COUNTERS

STORAGE & TRANSPORT ▼

COUNTERS



FRONT COUNTER

UNDERCOUNTER (OPTIONAL)



CASE FOR PIPE AND COUNTERS

VINYL CARE ▼

WARNING! Do not apply adhesive tape of any kind to the surface of printed vinyl. Doing so will damage the printing and WILL void the warranty.

When storing vinyl, make sure it is completely dry to prevent mold and mildew.

Carefully roll top and skirt vinyl (do not wad up) to avoid creases and wrinkles.

Avoid placing heavy items on top of vinyl. Proper care will help the vinyl look good for years.

Clean the outside of the vinyl with soap & water. Vinyl preservatives extend the life of the vinyl. Do not scrub printed custom graphics.

Avoid letting the cloth backing on the vinyl get dirty or stained. If it gets dirty, clean with warm soap and water and let it dry thoroughly before storing.

Do not fold the frame while the skirt is still snapped on. If the vinyl is cold it will be tight when snapping to the frame.

When unsnapping hold near the snap and pull straight. Do not yank or pull from a distance.

PVC FRAME CARE ▼

Clean with soap and water. For stronger stains use a mild abrasive household cleaner such as Clorox Soft Scrub and wipe afterwards with water. Do not use dry abrasive cleaners. This will scratch the PVC finish.

Clean any dirt build-up on the inside of the fittings and outside of the pipe ends. This will make it easier for insertion when assembling and removal when disassembling.

COUNTER & SHELF CARE ▼

Clean with soap and water. For stronger stains use a mild abrasive household cleaner such as Clorox Soft Scrub and wipe afterwards with water.

Do not set items on the under counter shelf that will bulge or spill on the skirt. Center heavy items over the cross brace. Slide the cross brace towards the center legs for maximum support.

OUTDOOR USE ▼

Stakes and tie downs or sandbags are recommended in windy conditions. For heavy winds or wind gusts it is recommended to remove the vinyl top & skirt.

When setting up on an uneven ground or surface make sure that all feet are touching firmly.

Avoid setting up on muddy ground. It will stain the bottom of the 4 Foot skirt.