

# Alumalite Counters

## Classic Counters

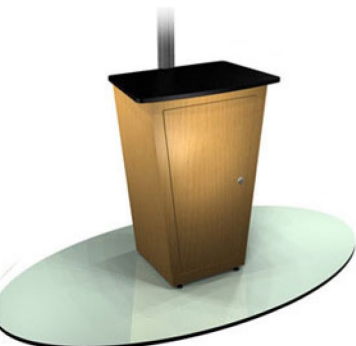

Free Standing Counter

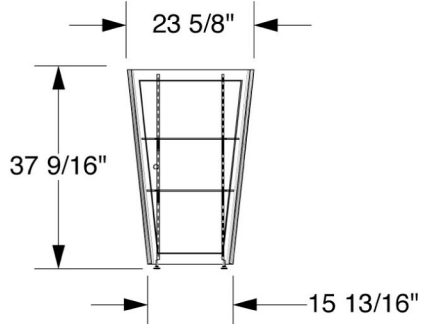
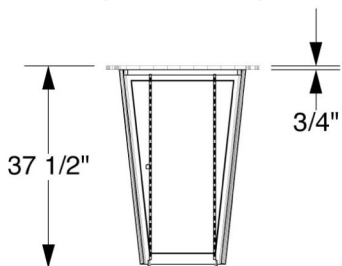
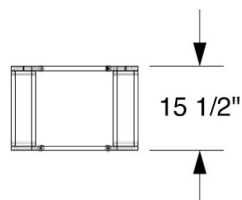
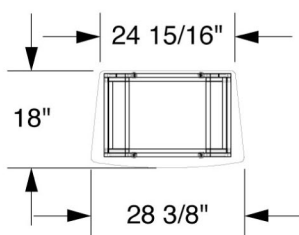

Fixed Counter

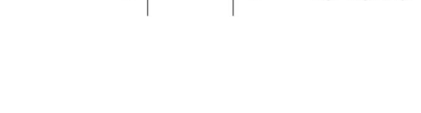

## Double Wide Counters

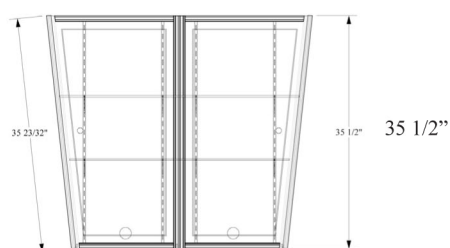
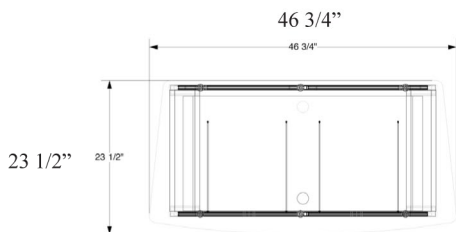
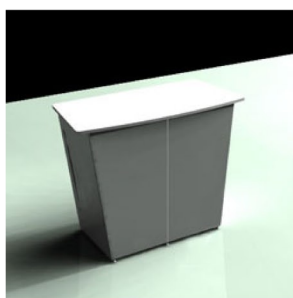
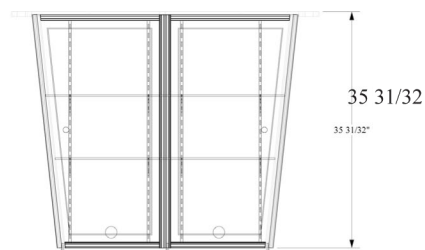
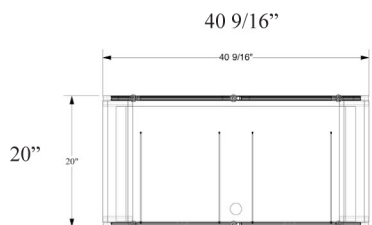

## Lineare Counters

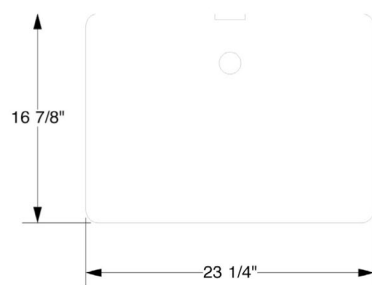
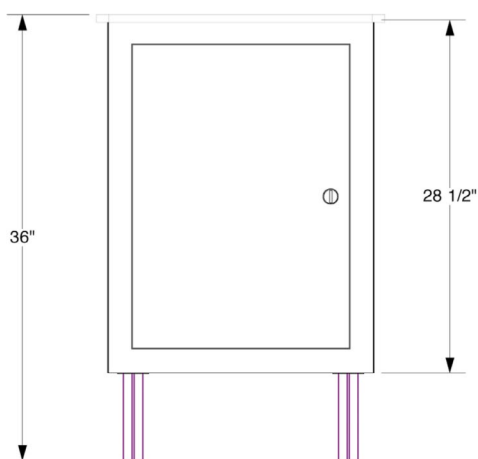

## Swing Counter

**Front**  
38.125"W X 23.5"H

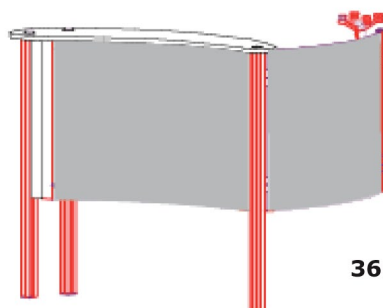

**Side**  
36.1875"W X 23.5"H