

AZ3

10' AlumaLite Zero Hybrid Display

Graphic Specs/E-proof Approval

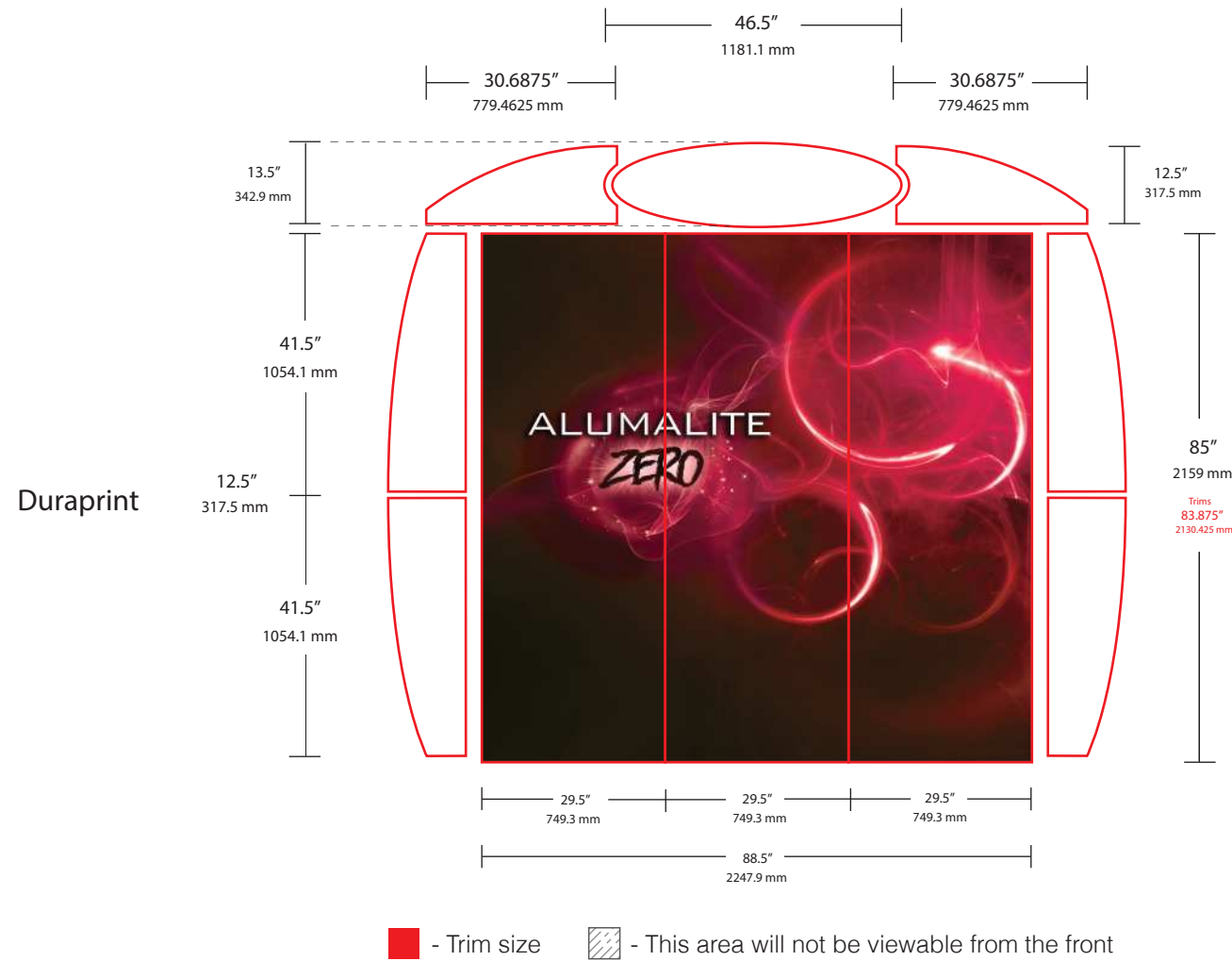

Important

YOUR PROOF MUST BE APPROVED BY:

TO MEET SHIP DATE OF:

NOTE: Changes to this proof will require approval of revised proof.

Please choose one

- A. This proof is approved. I authorize the production of my graphics without viewing a test strip. Proof must be approved by noon PST to start production the same business day.
- B. Please send me a test strip. I understand that selecting this option will add additional production and shipping time. Please confirm turn-around time with your project manager.

NOTE:

All graphics must be built with a resolution of at least 100 dpi at the full graphic layout size. All graphics must be created in CMYK color mode to ensure optimal color matching. If specific color matching needs are essential, you MUST provide a PMS color and request a test strip or we cannot guarantee exact color matching. This will add 4+ days to your production schedule, but will ensure a match closest to your preferred color. Make sure to flatten all images (if working in Photoshop) and outline all text (if working in Illustrator) to ensure nothing is lost. Be aware of all viewable areas and guides that may cut your graphic off (ie. dotted lines show where the graphic wraps around and may not be visible from the front). Production will not begin until final approval of E-proof is received.

Acceptable File Formats:
 Photoshop (.PSD or .TIFF), Illustrator (.AI or .EPS).
 We can not accept InDesign (.ID), Quark, CorelDraw, Publisher, PowerPoint or Word Document files

If you are using any software other than Adobe Illustrator or Photoshop to create your layout, and do not require color matching, please submit your artwork as one of the following file types: JPG, PDF or TIFF.

3D Model



Zero Counter

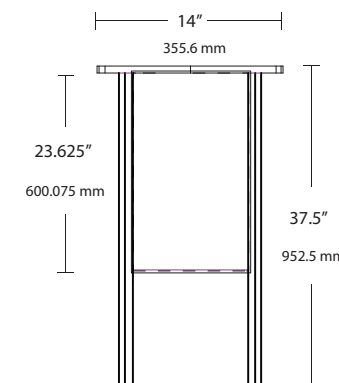

Date: _____

Order #: _____

Signature: _____

Client: _____

AZ3

10' AlumaLite Zero Hybrid Display

Graphic Specs/E-proof Approval

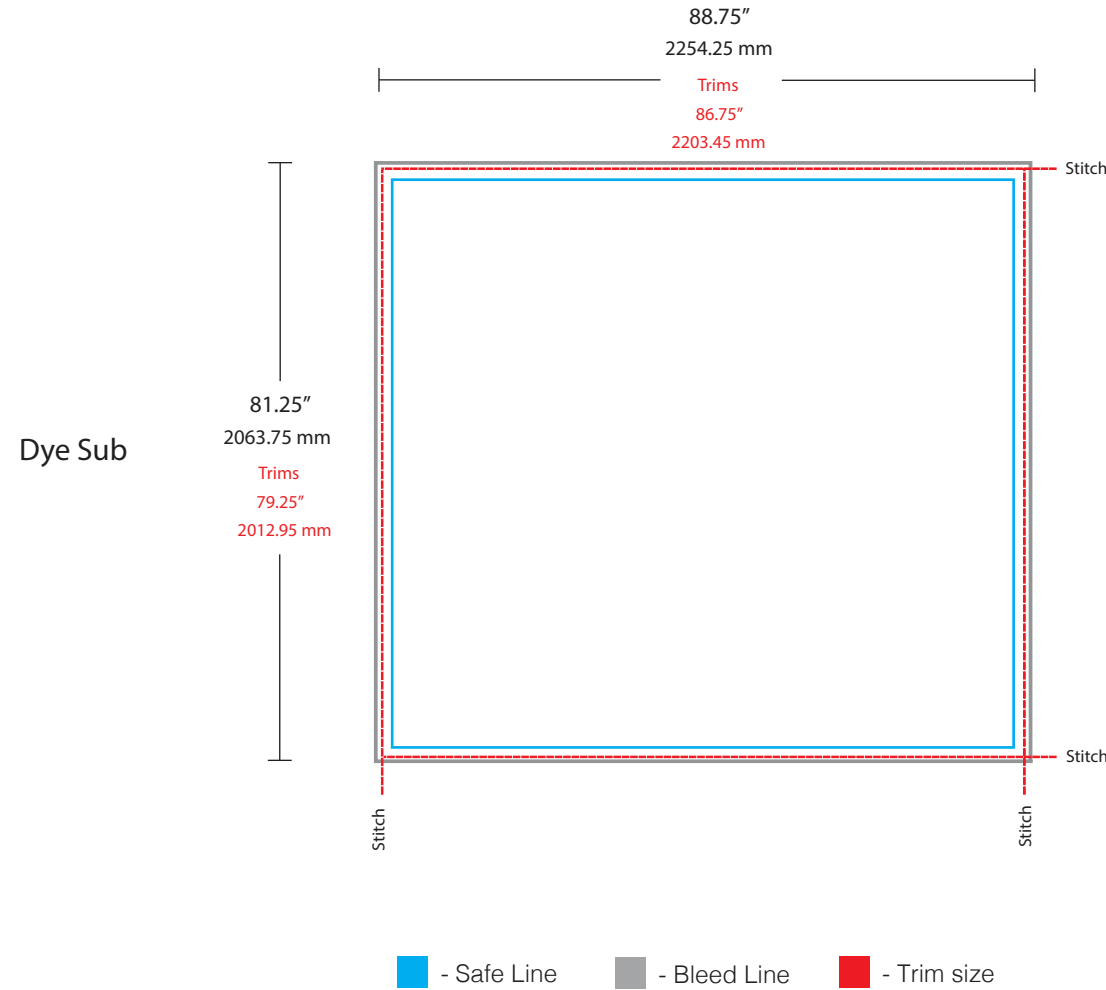

Important

YOUR PROOF MUST BE APPROVED BY:

TO MEET SHIP DATE OF:

NOTE: Changes to this proof will require approval of revised proof.

Please choose one

- A. This proof is approved. I authorize the production of my graphics without viewing a test strip. Proof must be approved by noon PST to start production the same business day.
- B. Please send me a test strip. I understand that selecting this option will add additional production and shipping time. Please confirm turn-around time with your project manager.

NOTE:

All graphics must be built with a resolution of at least 100 dpi at the full graphic layout size. All graphics must be created in CMYK color mode to ensure optimal color matching. If specific color matching needs are essential, you MUST provide a PMS color and request a test strip or we cannot guarantee exact color matching. This will add 4+ days to your production schedule, but will ensure a match closest to your preferred color. Make sure to flatten all images (if working in Photoshop) and outline all text (if working in Illustrator) to ensure nothing is lost. Be aware of all viewable areas and guides that may cut your graphic off (ie. dotted lines show where the graphic wraps around and may not be visible from the front). Production will not begin until final approval of E-proof is received.

Acceptable File Formats:
Photoshop (.PSD or .TIFF), Illustrator (.AI or .EPS).
We can not accept InDesign (.ID), Quark, CorelDraw, Publisher, PowerPoint or Word Document files

If you are using any software other than Adobe Illustrator or Photoshop to create your layout, and do not require color matching, please submit your artwork as one of the following file types: JPG, PDF or TIFF.

3D Model



Zero Counter

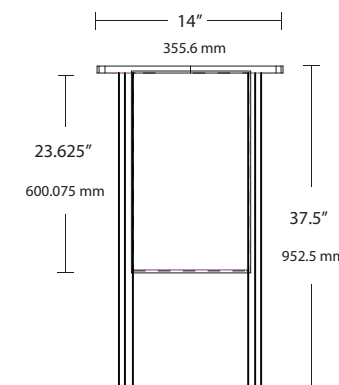

Date: _____ Order #: _____ Signature: _____ Client: _____